

Installation instructions

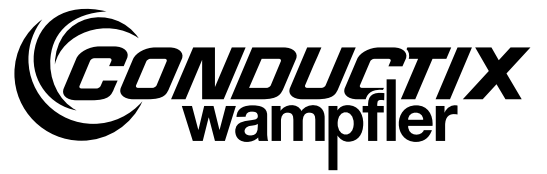

Festoon systems for C-rails

Program 0230 / 0240 / 0250 / 0255 / 0260



Festoon systems for C-rails

Program 0230 / 0240 / 0250 / 0255 / 0260

Contents

1	General notes	5
1.1	Information about these installation instructions	5
1.2	Limitation of liability	5
1.3	Copyright	6
1.4	Spare parts	6
1.5	Material defects	6
1.6	Technical support	6
2	Safety instructions	7
2.1	General safety information	7
2.2	Personnel requirements	8
2.2.1	Qualifications	8
2.2.2	Unauthorized personnel	8
2.2.3	Instruction	8
2.3	Personal protective equipment	9
2.4	Intended use	10
2.4.1	Improper use	10
2.5	Protective measures taken by the operator/user	11
2.6	Particular risks	12
2.7	Behavior in case of accidents and malfunctions	14
3	Technical specifications	15
3.1	General specifications	15
3.2	Interfaces	15
3.3	Operating conditions	15
4	Product description and function	16
4.1	Overview of the festoon system	16
4.2	Brief description	17
4.3	Description of assemblies	17
4.4	Working and danger areas	23
4.5	Operating modes	24
4.5.1	Automatic operation	24

Festoon systems for C-rails

Program 0230 / 0240 / 0250 / 0255 / 0260

4.5.2	Manual operation	24
5	Transport, packaging and storage	25
5.1	Transport	25
5.1.1	Safety instructions for transport	25
5.1.2	Transport inspection.....	26
5.2	Packaging	26
5.3	Storage of packed parts	27
6	Installation and commissioning	28
6.1	Safety	28
6.2	Preparation	30
6.3	Installation	30
6.3.1	Installing the track profiles.....	31
6.3.2	End clamp and end stop	33
6.3.3	Cable trolley	34
6.3.4	Towing trolley.....	36
6.3.5	Ideal control trolley.....	37
6.3.6	Arrangement of round cables.....	38
6.3.7	Arrangement of flat cables	40
6.3.8	Mounting round cable clamps	41
6.3.9	Installing flat cable clamps	42
6.3.10	Mounting the towing rope.....	43
6.3.11	Damping device	44
6.4	Testing and commissioning	44
6.4.1	Commissioning test list	46
7	Operation	52
7.1	Safety	52
7.2	Function.....	54
8	Maintenance and service	55
8.1	Safety	55
8.2	Maintenance/inspection plan	57
8.2.1	Inspection on deactivated system	58

Festoon systems for C-rails

Program 0230 / 0240 / 0250 / 0255 / 0260

8.2.2	Inspection of towing rope and criteria for replacement	59
8.2.3	Inspection on moving system	60
8.2.4	Logging	60
8.2.5	Maintenance of the festoon system	61
8.2.6	Wearing parts	63
8.2.7	Wear limits	63
8.2.8	Repeat inspections	64
8.2.9	Repair	64
9	Troubleshooting	65
10	Disassembly and disposal	66
10.1	Safety	66
10.2	Disassembly	68
10.3	Disposal	68
11	Additional documentation	69
11.1	Installation declaration	69
11.2	Documentation for electrical equipment	69
11.3	Replacement parts list	69
11.4	Product observations	71
11.5	Final handover document	73

Festoon systems for C-rails

Program 0230 / 0240 / 0250 / 0255 / 0260

1 General notes

1.1 Information about these installation instructions

These installation instructions make it possible for you to work with the festoon system safely and efficiently (product ranges 0230–0260).

The installation instructions are a component of the festoon system and must be kept in the immediate vicinity of the festoon system and accessible to personnel at all times. Personnel must carefully read and understand these installation instructions before starting any work. The basic prerequisite for safe work is compliance with all safety and operating guidelines in these installation instructions.

Furthermore, local accident protection regulations and general safety regulations apply for the area of use of the festoon system.

Illustrations are provided for basic understanding and may deviate from the actual implementation of the festoon system.

In addition to these installation instructions, the attached instructions for installed components also apply.

1.2 Limitation of liability

All data and information in these installation instructions has been compiled while taking the valid standards and regulations as well as the state-of-the art and our long years of experience and knowledge into consideration.

The manufacturer is in no way liable for damages resulting from:

- Failure to comply with installation instructions
- Improper use
- Employment of untrained personnel
- Unauthorized modifications
- Technical changes
- Use of unauthorized replacement parts or accessories

The actual scope of delivery may differ from the explanations and illustrations here depending on special implementations, the inclusion of additional order options, or due to the latest technical changes.

The obligations specified in the scope of delivery, the general terms of business, and the delivery terms of the manufacturer apply, along with the legal regulations valid at the time of conclusion of the contract.

All products are subject to technical changes during the process of improvement of characteristics of use and continued development.

Festoon systems for C-rails

Program 0230 / 0240 / 0250 / 0255 / 0260

1.3 Copyright

These installation instructions are subject to copyright and exclusively intended for internal use.

Provision of the installation instructions to third parties, duplications in any form - even in part - as well as the reuse and/or disclosure of their content are not permitted without the written approval of the manufacturer, except for internal use.

Violations will result in the obligation to compensate for damages. Other rights reserved.

1.4 Spare parts



Safety risk due to wrong spare parts!

Wrong or faulty spare parts can impair safety as well as result in damages, malfunctions or complete failure.

Use only original spare parts of the manufacturer!

Obtain spare parts from licensed dealers or directly from the manufacturer. See the last page of these installation instructions for the address.

1.5 Material defects

The regulations about material defects are listed in the general terms and conditions of business.

1.6 Technical support

For technical support please contact our staff from the Customer Support Department. See the last page of these installation instructions for contact information.

Our employees are also always interested in new information and experience from use that can be valuable for the improvement of our products.

Festoon systems for C-rails

Program 0230 / 0240 / 0250 / 0255 / 0260

2 Safety instructions

2.1 General safety information

Safety and hazard information is identified in these installation instructions by symbols. Signal words are used in these safety instructions to indicate the degree of hazard. Always observe safety and hazard information and work carefully to avoid accidents, bodily harm or property damage!



... indicates an immediately hazardous situation, which if not avoided, may result in death or serious injury.

DANGER!



... indicates an immediately hazardous situation due to electricity, which, if not avoided, may result in death or serious injury.

DANGER!



... indicates a possibly hazardous situation, which if not avoided, may result in death or serious injury.

WARNING!



... indicates a possible danger of burning if not avoided.

WARNING!



... indicates a possibly hazardous situation due to electricity, which, if not avoided, may result in death or serious injury.

WARNING!



... indicates a possibly hazardous situation, which if not avoided, may result in moderate or minor injury.

CAUTION!



Tips and recommendations:

... provide useful tips and recommendations as well as information for efficient and trouble-free operation.



... indicates actions that will help you prevent material damage.

ATTENTION!

Festoon systems for C-rails

Program 0230 / 0240 / 0250 / 0255 / 0260

2.2 Personnel requirements

2.2.1 Qualifications



WARNING!

Injury due to insufficient qualifications!

Improper use can result in serious injury to person and property.

→ Allow only qualified personnel to carry out all activities!

The following qualifications have been mentioned in these installation instructions for different areas of operation:

- **Trained personnel/operators**
have been instructed by the operator about the tasks assigned to them and the possible hazards resulting from improper use.
- **Qualified specialists**
Due to their technical education, knowledge, and experience as well as knowledge of the applicable specifications, are capable of carrying out the tasks assigned to them and to detect and avoid possible dangers independently.
- Personnel may only be authorized if it can be expected that they carry out their work reliably. Personnel whose reactions are influenced by drugs, alcohol, or medications may not be authorized.
- Locally applicable age and qualification regulations must be followed during selection of personnel.

2.2.2 Unauthorized personnel



WARNING!

Danger due to unauthorized personnel!

Unauthorized personnel who do not meet the requirements described here do not understand the danger in the work area.

- Keep unauthorized personnel away from the work area.
- In case of doubt, address personnel and warn them away from the work area.
- Cease working as long as unauthorized personnel are present in the work area.

2.2.3 Instruction

Before commissioning, the personnel must be instructed by the operator. For better tracking, log the performance of this instruction as follows:

Date	Name	Type of instruction	Instruction given by	Signature

Fig. 1: Example of instruction log

Festoon systems for C-rails

Program 0230 / 0240 / 0250 / 0255 / 0260

2.3 Personal protective equipment

Always to be worn

For all work



Protective helmet

For protection against falling or flying parts and materials.



Protective gloves

For the protection of hands against friction, scrapes, stabbing or deep wounds, as well as against contact with hot surfaces.



Work safety clothing

Primarily for protection against entrapment by moving machine parts. Working clothes must be close fitting with a low resistance to tearing; they must have close-fitting sleeves and no protruding parts.



Safety shoes

Used to protect from falling heavy parts and slipping on slippery floors.

For special tasks, wear

Special protective equipment must be used when carrying out certain tasks. The need for is detailed separately in the individual sections of this manual.



Safety goggles

To protect the eyes against harmful influences, such as strong light, chemicals, dust, splinters or effects of the weather.



Hearing protection

For protection against loud noises and to prevent acoustic trauma.



Respirator (FFP-3 – according to country-specific requirements)

For protection against materials, particles, and organisms. In this case: Protection against dust arising from the abrasion of carbon brushes and the PVC insulation of the conductor rail.

Festoon systems for C-rails

Program 0230 / 0240 / 0250 / 0255 / 0260

2.4 Intended use

The festoon system is exclusively designed and built for the intended use described here.

Festoon systems program 0230-0260 are intended for the installation and operation of an electrical supply line for track-based mobile consumers, such as cranes and lifting gears in industrial environment.

Other uses are only permitted after written approval by Conductix-Wampfler.



WARNING!

Possible injury resulting from improper use!

Any application that deviates from or goes beyond the intended use of the festoon system can result in a hazardous situation.

Use the festoon system only for its intended use.

- Comply strictly with all specifications of these installation instructions.
- Forbid the following uses of the festoon system.

The following uses in particular are considered improper use:

- Use of the festoon system with accessories not permitted and not authorized by the manufacturer.
- Operation of the festoon system by uninstructed personnel.
- Operation of the festoon system without its being installed on a proper foundation/floor.
- Exceeding projected load capacities
- Exceeding projected speeds
- Excessive acceleration
- Use of unsuitable cables
- Changing atmospheric conditions (including a change to projected physical location)

Claims of any kind due to damages from improper use are excluded.

The operator bears sole liability for any damages due to improper use.

2.4.1 Improper use

Improper use particularly includes the following types of use:

- Exceedance of projected loads
- Exceedance of projected speeds
- Higher accelerations than projected
- Use of unsuitable cables
- Change in ambient conditions (spatial change to the planned installation site)
- Overloading of electrical components
- Bridging and/or disconnection of electrical sensors or switches
- Use on technically unsuitable guide systems (such as dimensionally inaccurate or corroded track beams, poorly aligned beam joints, etc.)

Presence of projecting edges at an insufficient clearance on the crane structure around the cable festoon.

Festoon systems for C-rails

Program 0230 / 0240 / 0250 / 0255 / 0260

2.5 Protective measures taken by the operator/user

The festoon system is used in an industrial setting. The operator of the festoon system is thus subject to legal requirements related to workplace safety. In addition to the safety guidelines in these installation instructions, the safety, accident protection, and environmental protection regulations applicable to the place of operation of the festoon system must be followed. This particularly implies that:

- The operator must ensure that the festoon system will only be used for its intended purpose.
- The operator must be informed of applicable workplace safety regulations and carry out a risk assessment to detect additional dangers resulting from the specific working conditions in the place of operation of the festoon system. This must be implemented in the form of operating instructions for the operation of the festoon system.
- For the entire period of use of the festoon system, the operator must check whether the operating instructions prepared correspond to the current state of regulations, and update the operating instructions as needed.
- The operator must clearly regulate and determine responsibilities for installation, operation, troubleshooting, and maintenance.
- The operator must ensure that all employees involved with the festoon system have read and understood these installation instructions. Moreover, the operator must train personnel at regular intervals and inform them of the dangers.
- The operator must provide personnel with the protective gear required.

Furthermore, the operator is responsible for ensuring that the festoon system is always in a technically perfect condition. The following thus apply:

- The operator must ensure that the maintenance schedule described in these installation instructions is followed.
- The operator must regularly have all safety systems checked for functionality and completeness.

Festoon systems for C-rails

Program 0230 / 0240 / 0250 / 0255 / 0260

2.6 Particular risks

The following section lists residual risks determined based on a risk assessment.

- Follow the safety instructions listed here and the warnings in other sections of these installation instructions in order to reduce health hazards and avoid dangerous situations.



WARNING!

Danger of death due to hanging loads!

When lifting loads, there is a danger of death from falling parts or those swinging out of control.

- Never step under hanging loads
- Move loads only under supervision
- Follow the specifications for the attachment points provided
- Do not attach to projecting machine parts or to eyes on installed components. Be sure the connection elements are firmly seated
- Use only authorized lifting accessories and connection elements with sufficient load capacity
- Do not use torn or worn ropes or straps
- Do not attach ropes or straps to sharp corners and edges, and do not knot or twist them.
- Set down the load when leaving the workplace



WARNING!

Danger of injury from moving components!

Incautious handling of the festoon system can lead to severe injury and damage to the festoon system.

- Be sure that the festoon system does not start by itself
- While it is moving, do not reach into moving parts, particularly the interface between the buffer and buffer plate.
- Block off the dangerous area under the system



DANGER!

Danger of injury due to electrocution!

Danger of severe injury or death from electric current.

- The system engineer/operator must ensure that no projecting contours near the cable-festoon system are able to damage the cables
- Regularly check cables for wear
- Before working on the festoon system, the system must be disconnected from power using the main switch, and secured against unauthorized, unintentional, and/or erroneous activation. In special cases where there is no main switch, the power disconnection must be carried out according to the specifications of the system manufacturer. Check parts disconnected from power, then ground and short-circuit them. Insulate neighboring parts that are connected to power!
- Before each commissioning, the crane manufacturer must perform an insulation test, in accordance with the local technical standards, regulations and laws, for the complete system in which the cable-festoon system is installed
- Provide electrical protection measures in accordance with the regulations for the system

Festoon systems for C-rails

Program 0230 / 0240 / 0250 / 0255 / 0260



WARNING!

Risk of fire!

Risk of fire if undersized cables are used!

- Do not overload the cables
- Always comply with the necessary cross-section of cables
- System engineers must design the dimensioning and protective electrical devices in accordance with the permissible load capacity of the cables
- Connections may only be made by specialist electricians



CAUTION!

Danger of tripping on projecting parts!

When working on the festoon system, there is a risk of tripping.

- When walking in the work and danger area, be careful of projections and depressions in the floor. Loose objects must not be left on the floor



WARNING!

Danger of crushing!

On complete installation of the cable-festoon system, there is a risk of crushing extremities between load carriers and track profiles.

When moving the cable-festoon system, there is a danger of crushing extremities between the buffer and buffer plate, as well as between the carriage and track profiles.

There is a risk of crushing of the hands when moving the C-rail into the rail connector/hanger clamp.

- Do not enter the danger area of the cable-festoon system when the system is moving or during assembly
- Use personal protective equipment (protective gloves, safety helmet, safety shoes) when moving the C-rail



DANGER!

Danger of being trapped!

There is a danger of being trapped when the cable-festoon system is moving.

- Do not enter the danger area of the cable-festoon system when the system is moving

Festoon systems for C-rails

Program 0230 / 0240 / 0250 / 0255 / 0260

2.7 Behavior in case of accidents and malfunctions

Measures to be taken in case of accident:

- Secure the location of the accident.
- Take first-aid measures.
- Keep personnel out of the danger area.
- Inform responsible parties at the place of operation.
- Alarm the rescue services.
- Make access ready for rescue vehicles.

Measures to be taken in case of malfunction:

- Secure the work area against entry.
- Involve qualified personnel for fault analysis.
- Involve authorized personnel for maintenance and repair.
- Shut down the system and secure it against unauthorized, unintentional, and/or erroneous activation.
- If injury to person and property can occur during breakdowns then Conductix-Wampfler must be informed immediately.

Festoon systems for C-rails

Program 0230 / 0240 / 0250 / 0255 / 0260

3 Technical specifications

3.1 General specifications

Designation	Value	Notes
Max. load capacity	20 to 125 kg	Regardless of the festoon product line selected
Max. travel speed	80 to 120 m/min	Regardless of the festoon product line selected

3.2 Interfaces

- **Mechanical:**
Hanging track (Conductix-Wampfler) to load-bearing structure (operator)
Ideal control trolley (Conductix-Wampfler) for control box (operator)
- **Electrical:**
Cables (Conductix-Wampfler) to cable connector on end clamp side (operator)
Cables (Conductix-Wampfler) to cable connector on drive link side (operator)
- **Delineation of responsibilities for assemblies/components:**
The main assemblies and components are fabricated and shipped by Conductix-Wampfler.
Purchased parts such as cable screw connectors, terminal boxes, and cables from other suppliers are used and partly installed by the operator themselves. Suitable selection is the responsibility of the system integrator / operator.
- **Delineation of responsibilities for tasks in setup, installation, commissioning:**
The setup, final installation, and commissioning, unless otherwise agreed, are the responsibility of the system integrator / operator.

3.3 Operating conditions

Environment:

For use in enclosed areas, open areas under cover, and outdoors.

Designation	Value	Notes
Max. temperature range	-30° to +80°C	Regardless of the festoon product line selected
Relative humidity	20% to 80%	
Max. operating speed	17.2 m/sec to 20.8 m/sec	
Max. wind speed	< 32.7 m/sec (at a standstill)	

Festoon systems for C-rails

Program 0230 / 0240 / 0250 / 0255 / 0260

4 Product description and function

4.1 Overview of the festoon system



The following image is a model illustration. Deviations are possible, depending on the type of construction. Please observe the project-specific documentation.

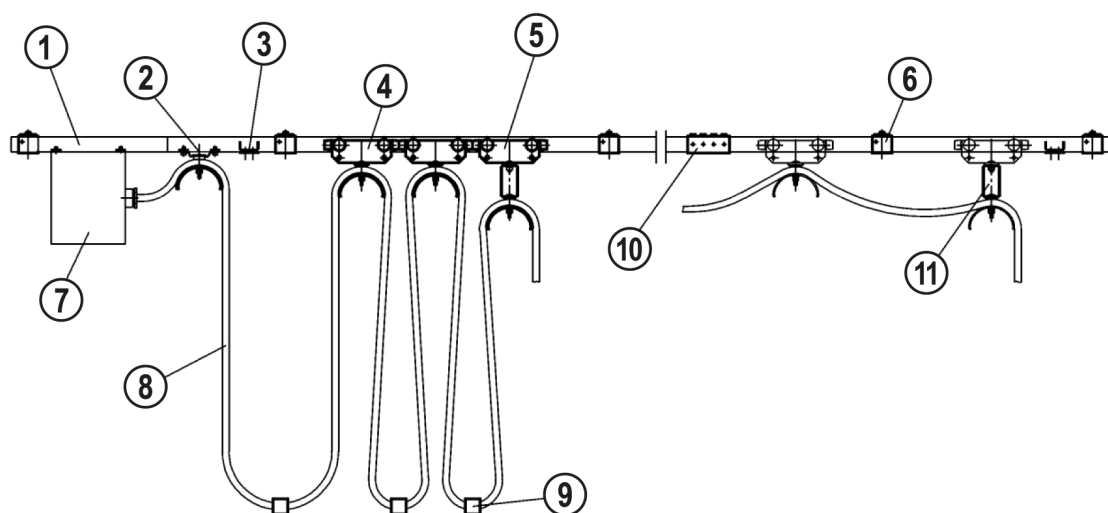

Fig. 2: Overview of festoon system towing trolley

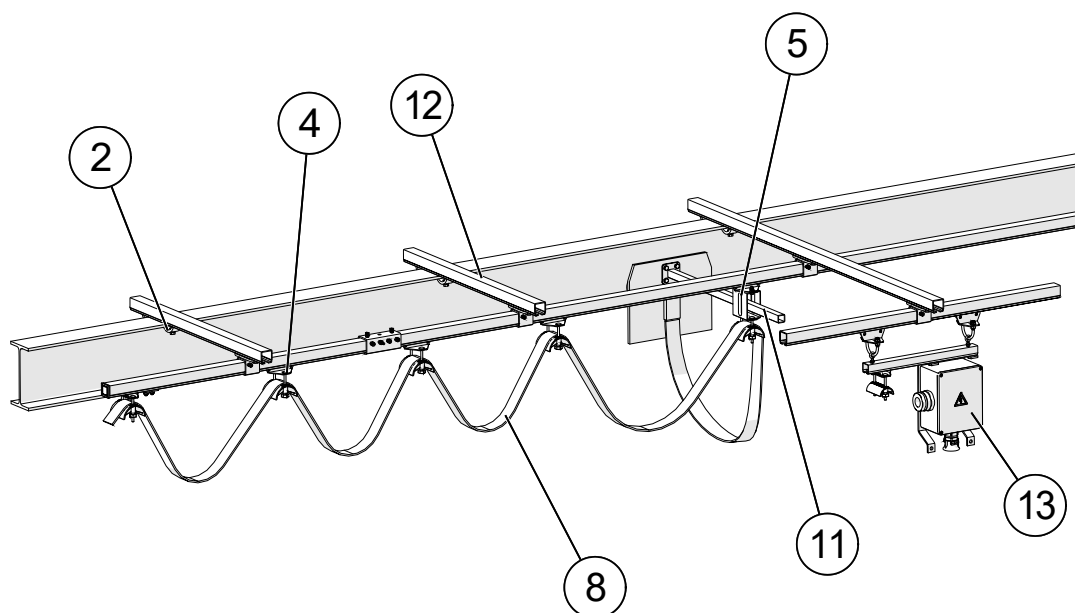

Fig. 3: Overview of festoon system with ideal control unit

Festoon systems for C-rails

Program 0230 / 0240 / 0250 / 0255 / 0260

Item	Name
1	C-rail
2	End clamp
3	End stop
4	Cable festoon
5	Towing trolley
6	Hanger clamp
7	Terminal box
8	Cables
9	Cable clamp
10	Rail connector
11	Towing arm
12	Cross arm
13	Ideal control trolley



CAUTION!

Use only cables suitable for cable-festoon systems!

- Double insulation
- Flexible design for frequent alternating bending stress
- Robust outer sheaths
- Use cables suitable for the application and ambient conditions

4.2 Brief description

A festoon system consists of C-rails, rail fastening material, end clamps, festoons, towing trolleys, and cables. A towing arm couples the towing trolley to the mobile consumer. The towing trolley pulls and/or pushes the following cable trolley.

The variant with ideal control unit also has a separate track parallel to the hosting device track. The system is controlled using a control button (not included in delivery) coupled to the control trolley. Depending on the project, towing rope, shock cord, and round or flat cable clamps may also be used.

The dimensions of the cable-festoon system can be found in the project-specific dimensional drawing.

4.3 Description of assemblies

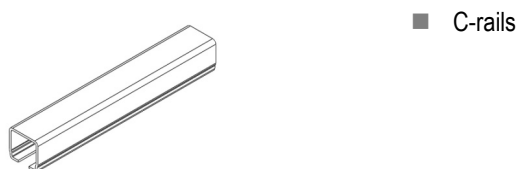

Fig. 4: C rails

Festoon systems for C-rails

Program 0230 / 0240 / 0250 / 0255 / 0260

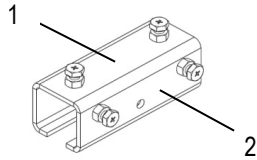

Fig. 5: Rail connector

- Track coupler, consisting of:
 - 1) Track coupler
 - 2) Set screw

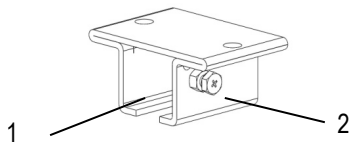

Fig. 6: Hanger clamp

- Hanger clamp, consisting of:
 - 1) Hanger clamp
 - 2) Locking screw

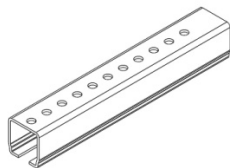

Fig. 7: Cross arm

- Cross arm

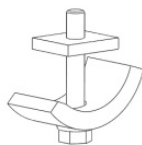

Fig. 8: Clamping bracket

- Clamping bracket
For fastening the cross arms to the supporting structure

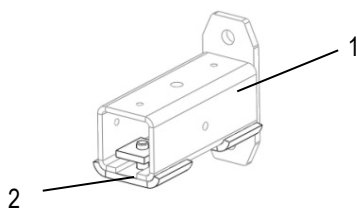

Fig. 9: Bracket for cross arms

- Bracket for cross arms, consisting of:
 - 1) Bracket
 - 2) Clamping part

Festoon systems for C-rails

Program 0230 / 0240 / 0250 / 0255 / 0260

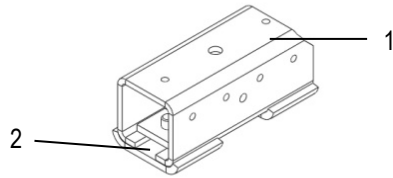

Fig. 10: Weld-on bracket for clamping arms

- Weld bracket for clamping arms, consisting of:
 - 1) Bracket
 - 2) Clamping part

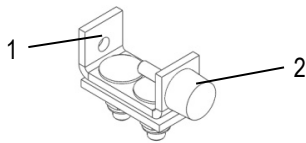

Fig. 11: End stop

- End stop, consisting of:
 - 1) End stop
 - 2) Rubber buffer



Fig. 12: Eye

- Eye
For the suspension of the stress-relieving cable

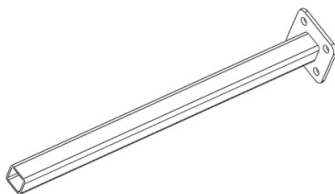

Fig. 13: Towing arm

- Towing arm

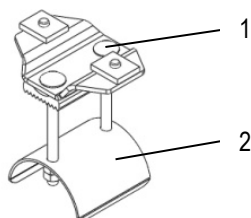

Fig. 14: End clamp

- End clamp, consisting of:
 - 1) End clamp, top part
 - 2) Support assembly

Festoon systems for C-rails

Program 0230 / 0240 / 0250 / 0255 / 0260

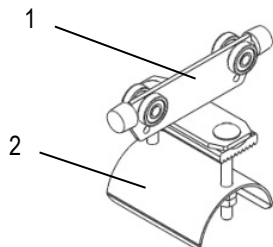

Fig 15: Cable festoon

- Cable festoon, consisting of:
 - 1) Cable festoon, upper part
 - 2) Support assembly

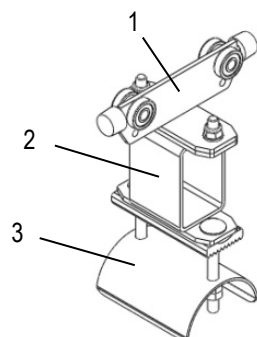

Fig. 16: Towing trolley

- Towing trolley, consisting of:
 - 1) Cable festoon, upper part
 - 2) Towing pipe
 - 3) Support assembly

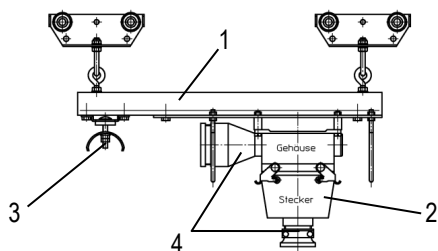

Fig. 17: Ideal control wagon with plug-in connection

- Ideal control trolley, consisting of:
 - 1) Control trolley, upper part
 - 2) Plug-in connector (or terminal box)
 - 3) End clamp for stress relief
 - 4) Cable screw connectors
 - 5) Housing

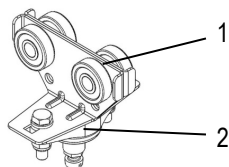

Fig. 18: Cable festoon with ball joint

- Cable festoon for cable holder, consisting of:
 - 1) Cable festoon, upper part
 - 2) Ball joint

Festoon systems for C-rails

Program 0230 / 0240 / 0250 / 0255 / 0260

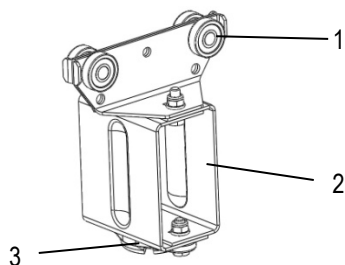

Fig 19: Towing trolley

- Towing trolley for cable holder, consisting of:
 - 1) Cable festoon, upper part
 - 2) Towing pipe
 - 3) Connection plate

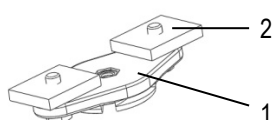

Fig. 20: End clamp

- End clamp for cable holder, consisting of:
 - 1) Connection plate
 - 2) Screw set

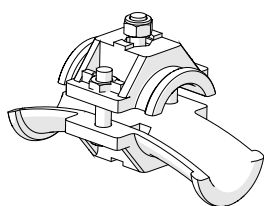

Fig 21: Cable holder

- Cable holder
Several cable support brackets can be used one above the other.
The largest should be placed uppermost.

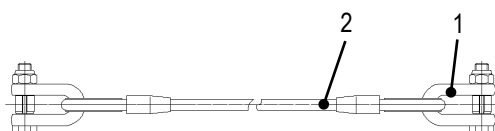

Fig 22: Stress-relieving cable

- Stress-relieving cable, consisting of:
 - 1) Shackle
 - 2) Steel cable

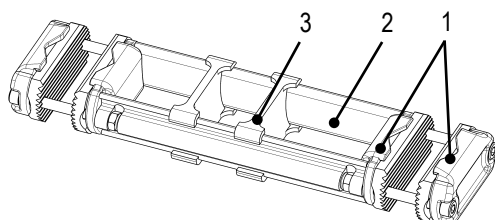
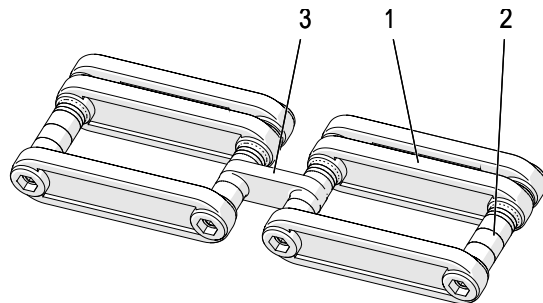

Fig 23: Round cable clamp

- Round cable clamp:
 - 1) Clamping part
 - 2) Clamp profile
 - 3) Spacer

Festoon systems for C-rails

Program 0230 / 0240 / 0250 / 0255 / 0260



■ Flat cable clamp, consisting of:

- 1) Clamping part
- 2) Spacer
- 3) Connecting part

Fig. 1: Flat cable clamp

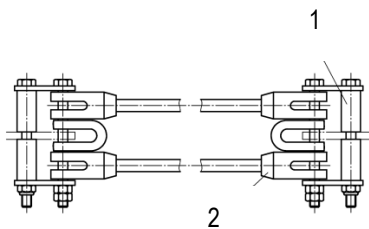

■ Damping assembly consisting of:

- 1) Fastening bracket
- 2) Shock cord

Fig. 2: Damping device

Festoon systems for C-rails

Program 0230 / 0240 / 0250 / 0255 / 0260

4.4 Working and danger areas

The following illustration shows the working area of the festoon system. There is a danger of injury from moving parts in this area.

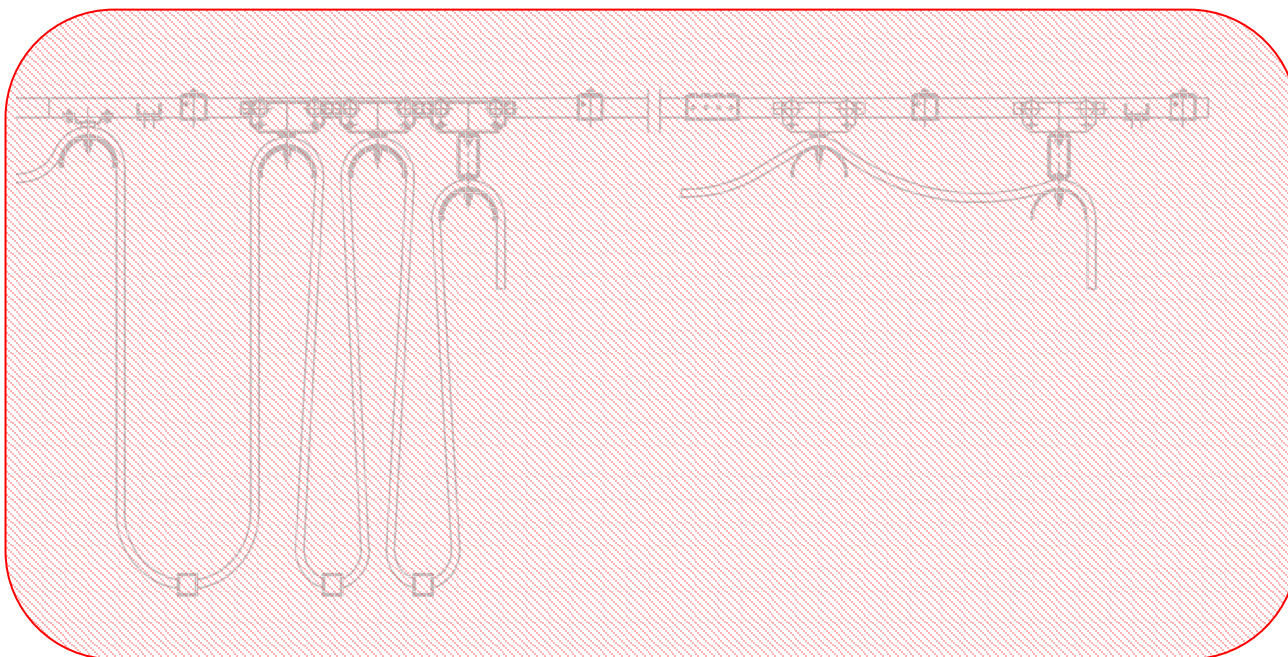

Fig 26: Working and danger areas

Working and danger areas:

- In the area under the festoon system
- Between cable trolleys
- Between cable trolleys and track profiles
- Between load carriers and track profiles
- In the vicinity of the cables



Danger of injury from moving components!

Contact with the festoon system during operation can lead to severe injuries and damage to the festoon system.

- During automatic operation, no-one may be located in or under the working area of the festoon system.
- In manual operation, ensure that no-one is in or under the working area of the cable-festoon system
- Block off the dangerous area under the system.

Festoon systems for C-rails

Program 0230 / 0240 / 0250 / 0255 / 0260

4.5 Operating modes

The festoon system can be operated in one of two modes:

- Automatic operation
- Manual operation

4.5.1 Automatic operation

The standard operating mode is automatic operation, in which the festoon system is operated via the consumer's controller. In this mode, no person may be in or under the working area of the festoon system. The customer must block off the working area.

4.5.2 Manual operation

Manual operation is used for commissioning, maintenance, and repair. It may be necessary to make adjustments directly at the festoon system and to monitor them.

Festoon systems for C-rails

Program 0230 / 0240 / 0250 / 0255 / 0260

5 Transport, packaging and storage

5.1 Transport

5.1.1 Safety instructions for transport



WARNING!

Danger of death due to hanging loads!

When lifting loads, there is a danger of death from falling parts or those swinging out of control.

- Never step under hanging loads.
- Block off the dangerous area under the system.
- Follow the specifications for the attachment points provided.
- Do not attach to projecting machine parts or to eyes on installed components. Be sure the connection elements are firmly seated.
- Use only authorized lifting accessories and connection elements with sufficient load capacity.
- Do not use torn or worn ropes or straps.
- Do not attach ropes or straps to sharp corners and edges, and do not knot or twist them.



CAUTION!

Possible damage from improper transport!

Improper transport can result in substantial property damage.

- Act with care when unloading packaged parts upon delivery as well as during internal transport, and observe the symbols and the hazard information on the packaging.
- Use only the attachment points provided.
- Wait to remove packaging material until just before installation.



WARNING!

Danger of crushing!

There is a risk of crushing hands and feet when handling components during transport.

- Secure the load during transport
- Use appropriate means of transport (lifting gear)
- Use personal protective equipment (protective gloves, safety helmet, safety shoes)



DANGER!

Risk of injury due to falling objects!

There is a risk due to falling objects in case of improper use (incorrect assembly, misuse, lack of maintenance).

- Secure the load adequately during transport
- Check the integrity of the packaging before transport
- Use appropriate means of transport (lifting gear)
- When packing, ensure that the packaging has the appropriate load-bearing capacity
- Use personal protective equipment (protective gloves, safety helmet, safety shoes)

Festoon systems for C-rails

Program 0230 / 0240 / 0250 / 0255 / 0260

5.1.2 Transport inspection

Check the delivery for completeness and transport damage immediately upon receipt (for C-rails and support arms see also TI0200-0217).

If transport damage is externally visible, proceed as follows:

- Do not accept delivery, or accept it only with reservations.
- Note the scope of damage on the transport documents or on the transporter's delivery note.
- File a complaint.



Claim every defect as soon as it is detected. Damage compensation claims may only be made within the applicable claim periods.

ATTENTION!

5.2 Packaging

The individual packaged parts must be packed according to the transport conditions to be expected. Only environmentally friendly materials have been used for packaging.

The packaging must protect the individual components from transport damages, corrosion, and other damage until installation. Thus do not destroy the packaging and remove it only just before installation.

Handling packaging materials:

Dispose of packaging material according to valid legal regulations and local guidelines.



CAUTION!

Environmental damage due to improper disposal!

Packaging material is a valuable resource and can be reused, processed or recycled in many cases.

- Dispose of packaging materials in an environmentally appropriate manner.
- Comply with locally applicable disposal guidelines; if necessary, engage a specialist with disposal.

Festoon systems for C-rails

Program 0230 / 0240 / 0250 / 0255 / 0260

5.3 Storage of packed parts

Store packed parts under the following conditions:

- Do not store outdoors.
- Store in a dry, dust-free place.
- Do not expose to aggressive media.
- Protect from direct sunlight.
- Avoid mechanical vibrations.
- Storage temperature: +5° to +50°C.
- Relative humidity: max. 50%.
- When storing for more than 3 months, check the general condition of all parts and the packaging at regular intervals. If necessary, add or replace the preservative.



Under some circumstances, there may be instructions for storage on the packed parts which go beyond the requirements listed here. Follow them appropriately.

ATTENTION!

Festoon systems for C-rails

Program 0230 / 0240 / 0250 / 0255 / 0260

6 Installation and commissioning

6.1 Safety

Personnel:

- Installation and commissioning may only be carried out by specially trained technicians.

Wear the following protective gear during all work of installation and commissioning:

- Work safety clothing
- Hard hat
- Safety shoes
- Protective gloves



WARNING!

Risk of death due to suspended loads!

When lifting loads, there is a risk of death due to parts falling or swinging out of control.

- Do not stand under suspended loads
- Cordon off the hazard area under the system
- Only move loads under supervision
- Follow the specifications for the attachment points provided
- Ensure that lashing components are properly seated. Ensure that lashing components are properly seated
- Use only approved lifting gear and lashing components with sufficient load capacity
- Do not use torn or worn ropes or straps
- Do not attach ropes or straps at sharp corners and edges, and do not knot or twist them
- Set loads down when leaving the workplace



WARNING!

Risk of injury due to improper installation and commissioning!

Improper installation and commissioning can result in serious injury to person and property.

- Before starting work, make sure there is sufficient space for assembly
- Handle open, sharp-edged components with care
- Ensure the installation area is clean and tidy! Loosely stacked or scattered components and tools can cause accidents
- Install components properly. Comply with specified screw-tightening torques
- Secure components so they cannot fall or topple



DANGER!

Risk of injury due to sharp edges!

The ends of the track-beam profiles can have sharp edges, especially if they were cut to size at the construction site and not deburred.

- Use personal protective equipment (protective gloves, safety helmet, safety shoes)

Festoon systems for C-rails

Program 0230 / 0240 / 0250 / 0255 / 0260



DANGER!

Danger of injury due to electrocution!

Danger of severe injury or death due to electric current.

- The system engineer/operator must ensure that no projecting contours near the cable-festoon system are able to damage the cables
- Regularly check cables for wear
- Before working on the cable-festoon system, the system must be disconnected from power using the main switch, and secured against unauthorized, unintentional, and/or erroneous activation. In special cases where there is no main switch, the power disconnection must be carried out according to the specifications of the system manufacturer. Check that parts disconnected from power are voltage free, then ground and short-circuit them. Insulate adjacent live parts!
- Before each commissioning, the crane manufacturer must perform an insulation test, in accordance with the local technical standards, regulations and laws, for the complete system in which the cable-festoon system is installed
- Provide electrical protection measures in accordance with the regulations for the system



DANGER!

Danger of being trapped!

There is a danger of being trapped when the cable-festoon system is moving.

- Do not enter the danger area of the cable-festoon system when the system is moving
- The customer must cordon off the danger area of the system
- Before starting work, shut down the system and secure it against accidental start



DANGER!

Risk of injury due to falling objects!

There is a risk due to falling objects in case of improper use (incorrect assembly, lack of attention).

- Cordon off a generous area underneath the system!
- Keep the time specialist fitters spend in the danger area to a minimum
- Wear a safety helmet!



CAUTION!

Risk of injury due to slipping and falling!

There is a risk of injury due to a dangerous environment or difficult installation conditions. For example, near cranes, in difficult-to-access locations, etc.

- Use personal protective equipment (protective gloves, safety helmet, safety shoes)
- Keep the location tidy
- Use only secure scaffolding
- Take appropriate safety measures



WARNING!

Unsafe operation of the system!

Falling system components due to installation errors!

- Do not stay in the danger zone under the system
- Comply with the maximum load and speed limits
- After completing the installation, perform a test run of the system only at very low speed
- Check the system in accordance with the maintenance plan and perform regular maintenance

Festoon systems for C-rails

Program 0230 / 0240 / 0250 / 0255 / 0260

6.2 Preparation

Tools needed:

- Drilling machine
- Metal drill
- Crescent wrench
- Corrosion protection
- Lubricant
- Gauges

6.3 Installation

Personnel:

- May only be carried out by trained technicians
- At least two people



CAUTION!

Danger of tripping on projecting parts!

When working on the festoon system, there is a risk of tripping.

- When walking in the work and danger area, be careful of projections and depressions in the floor. No loose objects may be left on the floor.



WARNING!

Danger of crushing!

On complete installation of the cable-festoon system, there is a risk of crushing extremities between load carriers and track profiles.

When moving the cable-festoon system, there is a danger of crushing extremities between the buffer and buffer plate, as well as between the carriage and track profiles.

There is a risk of crushing of the hands when moving the C-rail into the rail connector/hanger clamp.

- Do not enter the danger area of the cable-festoon system when the system is moving or during assembly.
- Use personal protective equipment (protective gloves, safety helmet, safety shoes) when moving the C-rail

Festoon systems for C-rails

Program 0230 / 0240 / 0250 / 0255 / 0260

6.3.1 Installing the track profiles

6.3.1.1 C-rails



ATTENTION!

- Before installing the C-rails, the rail segments and any rail curves must be dimensioned according to the path of the track. There is a rail connector at each butt joint in the rail.
- Comply with the suspension interval in the specifications of the product catalog for each system. The distance in curves is reduced to 2/3 of the distance on straight rails. The recommended suspension interval can be found in the system documentation.

6.3.1.2 Rail installation in ceiling and wall structures



ATTENTION!

- When installing C-rails on ceiling and wall structures at the customer's site, suitable track support brackets must be used.
- The direct fastening of C-rails by drilling and screwing the rails without the use of track support brackets should be avoided in any case. The restriction of the gap profile of the C-rails by screw heads, etc. would mean that the operability of the cable trolleys could no longer be assured.

6.3.1.3 Rail installation on I-beams using support arms

Support arms are first fastened to steel beams using girder clips, then the track support brackets are pushed into the support arms and screwed in place.



ATTENTION!

- The distance between the outer edges of the support arm and the steel beam must be at least 60 mm.
- The distance between the outer edge of the support arm and the middle of the steel beam must be at least 60 mm.

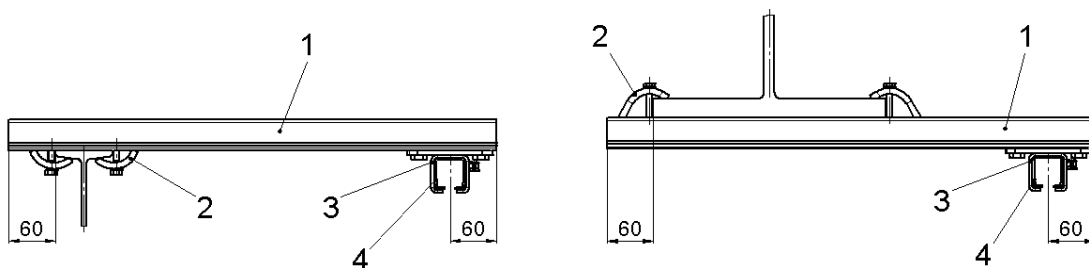

Fig 27: Rail installation using support arms on the upper or lower side of an I beam

Item	Designation
1	Support arm
2	Clamping bracket
3	Hanger clamp
4	C-rail

Festoon systems for C-rails

Program 0230 / 0240 / 0250 / 0255 / 0260

6.3.1.4 Rail installation on steel beams using welding brackets

Welding brackets are welded permanently to the steel beam. Then the support arms are screwed to the welding brackets and the track support bracket to the support arms. The welding process and implementation – in a manner suitable for the local conditions – are the responsibility of the operator!



→ The distance between the outer edge of the support arm and the middle of the steel beam must be at least 60 mm.

ATTENTION!

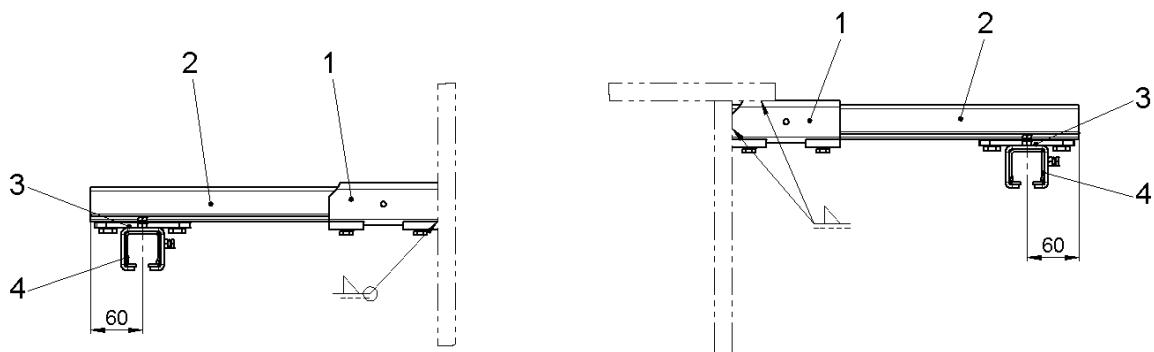

Fig 28: Rail installation using welding brackets on beam structure.

Item	Designation
1	Weld-on bracket
2	Cross arm
3	Hanger clamp
4	C-rail

6.3.1.5 Hanger clamp

Track support brackets are pushed onto the C-rails and fastened to the beam structure together with the C-rails. Alternatively, the track support brackets can first be fastened to the beam structure and then the C-rail segments pushed in. Then the C-rails are fastened to the track support brackets using set screws.



ATTENTION!

→ The C-rails must be secured in the first and last track support bracket against movement in the lengthwise direction. Holes are also bored in the rail struts, into which the set screws can be inserted. Ensure that the ends of the screws do not project on the inner side of the rail

Festoon systems for C-rails

Program 0230 / 0240 / 0250 / 0255 / 0260

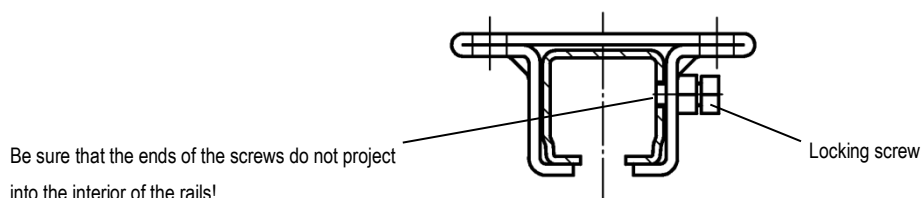

Fig. 3: Securing rails against slipping out

6.3.1.6 Track coupler

The track coupler is pushed onto the joint of the C-rail segment to half its length, and clamped in place. The correct position can be determined by the view hole. The second C-rail segment is then inserted and clamped without leaving a gap. Ensure that the locking screws are evenly tightened so that the rail is not offset.



ATTENTION!

→ The C-rails must be square and free of burrs.

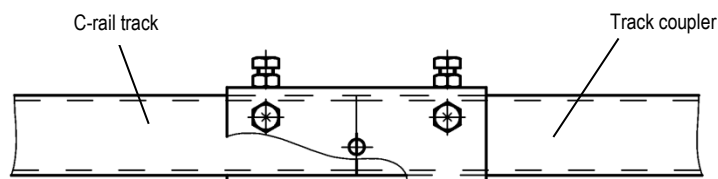

Fig 30: Track coupler

6.3.2 End clamp and end stop

6.3.2.1 End clamp and end stop product line 0230 / 0240

The end stop is pushed into the C-rail and clamped to limit the travel of the system. Space is left at the end of the rail for the end clamp.

The end clamp is fastened onto the rail behind the end stop.



ATTENTION!

The end stop must also be secured perpendicular to the rail using a screw.
The distance "E" between the middle of the end clamp and the end stop must be at least one cable trolley length.

Festoon systems for C-rails

Program 0230 / 0240 / 0250 / 0255 / 0260

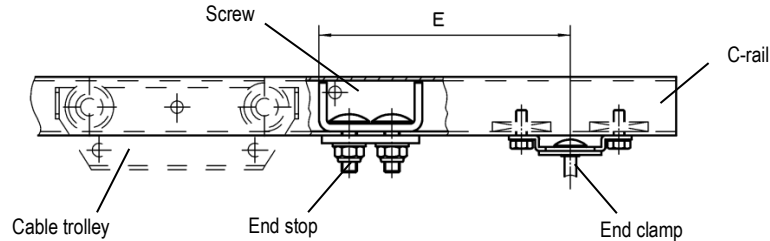

Fig. 32: End clamp and end stop product line 0230 / 0240

6.3.2.2 End clamp product line 0250 / 0255 / 0260

The end clamp is also fastened to the end of the track profile to limit travel. To do this, two holes 12.5 mm in diameter are bored at distance "a" (dimension "a" according to the product documentation) in the C-rail. Then the end clamp is pushed into the rail and screwed in place.



ATTENTION!

The distance "c" between the lower edge of the C-rail and the middle of the hole is:

- 0250 line: $c = 23.5 \text{ mm} \pm 0.5 \text{ mm}$
- 0255 line: $c = 30.0 \text{ mm} \pm 0.5 \text{ mm}$
- 0260 line: $c = 36.0 \text{ mm} \pm 0.5 \text{ mm}$

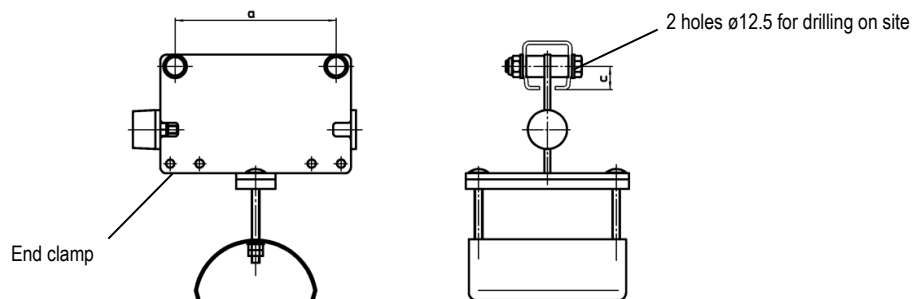

Fig.33: End clamp 0250 line

6.3.3 Cable trolley

Cable trolleys are pushed into the front of the track profile.



ATTENTION!

- The festoon system is adjusted at the factory for the corresponding track beam profile. Subsequent adjustment is not necessary.
- Fit the cable festoons with buffer on one side such that there is always one rubber buffer between two adjacent festoons

Festoon systems for C-rails

Program 0230 / 0240 / 0250 / 0255 / 0260

6.3.3.1 Cable trolleys with plastic cover and split nuts



ATTENTION!

- Nominal tightening torque for plastic half nuts: 1,5 Nm
- Max. permissible tightening torque: 2 Nm

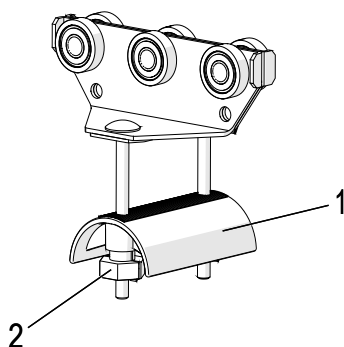

Item	Designation
1	Plastic cover
2	Half nut

Fig. 4: Plastic cover

6.3.3.2 Installing cable trolleys with ball joints and cable clip

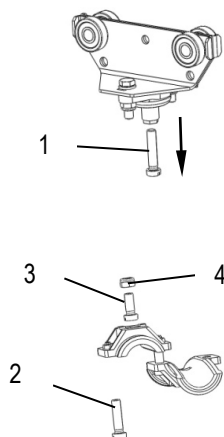

Step 1

→ Loosen the screw fastener (1) on the ball joint.

Step 2

→ Loosen the clamping screw (2).

→ Loosen and remove screw fastener (3) and nut (4).

Festoon systems for C-rails

Program 0230 / 0240 / 0250 / 0255 / 0260

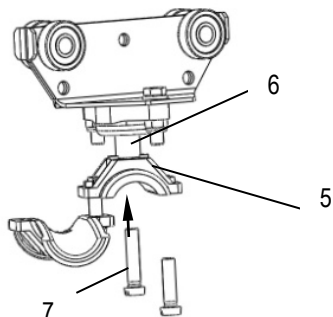

- Step 3
- Cable holder upper part (Item 5) and ball joint (Item 6) with screw (Item 7) securely tightened

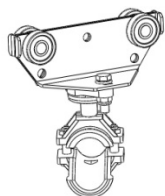

- Step 4
- Connect upper and lower parts of the cable clip with clamping screw.

Fig. 5: Installing the cable trolley with cable holder



ATTENTION!

- Several cable clips can be used one above the other. The largest should be placed uppermost.

6.3.4 Towing trolley



ATTENTION!

- The towing arm must have enough play in the towing arm window in all directions.
- The towing arm should be aligned such that it is in the center of the towing box.

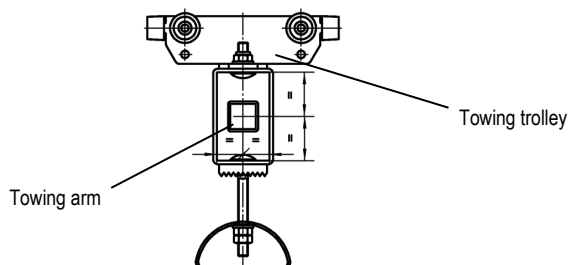

Fig.36.: Orientation of the towing arm

Festoon systems for C-rails

Program 0230 / 0240 / 0250 / 0255 / 0260

6.3.5 Ideal control trolley



ATTENTION!

- The connection and connection points of cables must be relieved of mechanical stress.
- For the ideal control trolley, the installation of an end clamp is necessary for strain relief of the cables.
- For longer tracks and/or outdoor systems, the installation of a brake is essential so that the ideal control trolley cannot be pulled back in its extended position by cable tension, and is not moved by the wind.
- The end clamp (2) relieves stress on the connecting cable
- Cables at screw connections must be fitted trailing downward. For vertical screw connections, provide a loop of cable hanging down
- Secure the cable such that there is no tensile stress on the terminals
- Use wire-end sleeves with insulation
- Connection for copper cables only

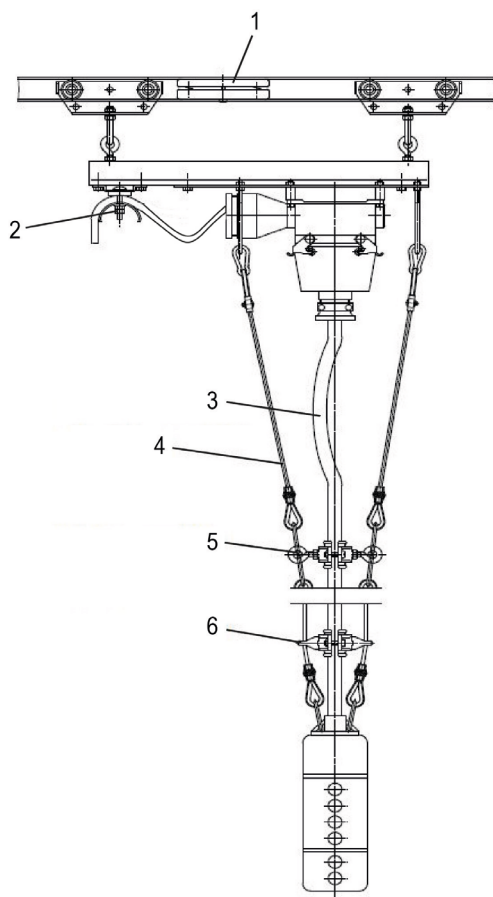

Item	Designation
1	Braking skids
2	End clamp for stress relief
3	Installed with excess cable
4	Stress-relieving cable
5	Cable clamp
6	Cable clamp

Fig. 6: Ideal control trolley

Festoon systems for C-rails

Program 0230 / 0240 / 0250 / 0255 / 0260

6.3.6 Arrangement of round cables



ATTENTION!!

Use only suitable cables!

The cables must meet the specified criteria set (see Section 4.1)



WARNING!

Danger of burning!

Danger of burning when using insufficiently dimensioned cables!

→ Always comply with the necessary cross-section of cables.



WARNING!

Danger due to improper installation of cables!

→ Improper arrangement of cables in the cable packet and in loops can damage the cables and lead to electrocution.

→ Use only specialist electricians to connect cables.

→ Inspect the cables regularly for wear and damage.

The projected cable setup for the festoon system is to be maintained. The following rules apply:

- Place the cable package towards the middle of the track beam so that the torque is in balance.
- Cables with large copper diameters are to be placed towards the center of the trolley and arranged symmetrically.
- When using cable trolleys with multiple cable support, the heaviest cables are to be placed on the uppermost support.
- When using cable trolleys with multiple cable support, the uppermost cables should be made slightly shorter than the cables below. Each layer of cables should be given somewhat less play than the cables below them.
- Each layer of cables should be given somewhat less play than the cables below them. When using round cable clamps, cables should be arranged on the outer surface of the supports that are suitable for anchoring the round cable clamps. Unshielded cables with a large copper diameter are preferred.
- The clamping braces of the layers must be screwed into place tightly enough to prevent thin cables from being pulled through during operation, while still not damaging the cables due to excessive clamping. If necessary, clamping pieces can be used.



ATTENTION!

Diameter differences:

The diameter of the round cables should be fairly uniform. This helps to ensure that they are tightly clamped on the cable supports.

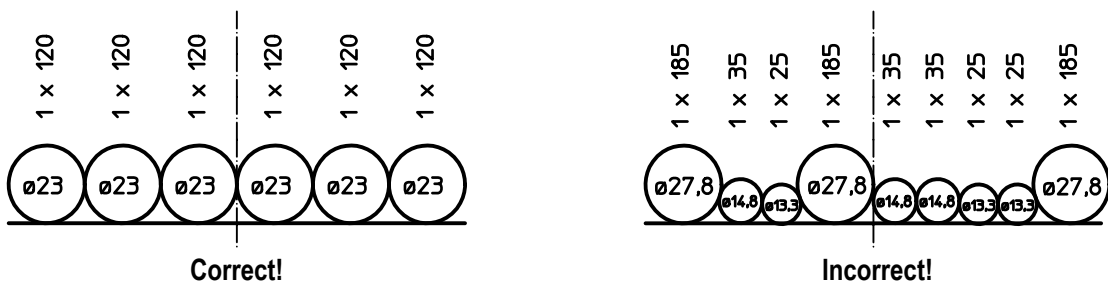

Fig. 38.: Diameter differences

Festoon systems for C-rails

Program 0230 / 0240 / 0250 / 0255 / 0260



ATTENTION!

Clamping pieces:

For differences in diameter of neighboring cables by more than 15 mm, clamping pieces should be used for tight clamping.

Additional clamping piece

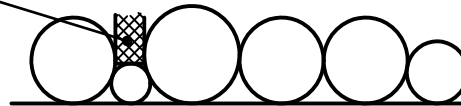

Fig. 39: Using clamping pieces



ATTENTION!

Cable balance:

When positioning the cables, it is important to ensure that torque is balanced. Place the thicker, heavier cables in the middle.

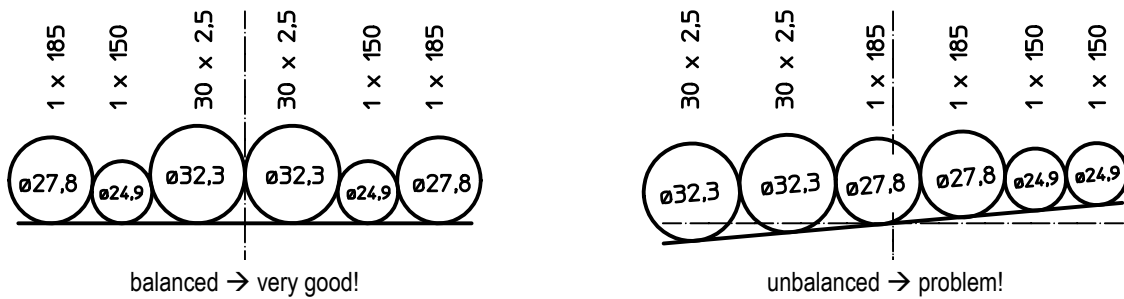

Fig 40: Cable balance

Festoon systems for C-rails

Program 0230 / 0240 / 0250 / 0255 / 0260

6.3.7 Arrangement of flat cables



ATTENTION!

Use only suitable cables!

The cables must meet the specified criteria set (see Section 4.1)



WARNING!

Danger of burning!

Danger of burning when using insufficiently dimensioned cables!

Therefore:

→ Always comply with the necessary cross-section of cables.



WARNING!

Danger due to improper installation of cables!

Improper arrangement of cables in the cable packet and in loops can damage the cables and lead to electrocution.

→ The cables may only be connected by an electrician.

→ Inspect the cables regularly for wear and damage.

The projected cable setup for the festoon system is to be maintained. The following rules apply:

- Place the cable package towards the middle of the track beam so that the torque is in balance.
- When using layered flat cables, give each layer of cables slightly less slack than the layer below.
- When using cable trolleys with multiple cable support, the uppermost cables should be made slightly shorter than the cables below. Each layer of cables should be given somewhat less play than the cables below them.
- Cables with large copper diameters are to be placed symmetrically to the center of the trolley and at the top of the cable package.
- When using flag cable clamps, only the uppermost cables are clamped. The other cables must be freely movable in the flat cable clamp window.

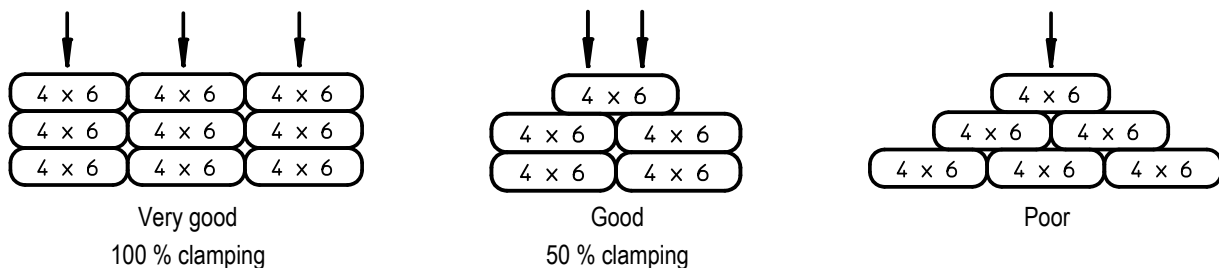
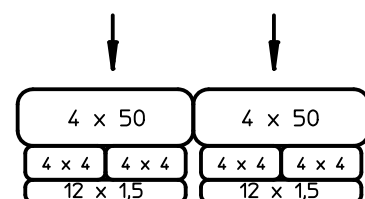

Fig. 41: Laying flat cables

Thicker cables (such as 4x50) are to be placed at the top of the cable package. This allows for good heat dissipation and tight clamping of smaller cables. Traction forces that occur during movement can be taken up by these cables.



Festoon systems for C-rails

Program 0230 / 0240 / 0250 / 0255 / 0260

6.3.8 Mounting round cable clamps



CAUTION!

Damage to the cables and the cable-festoon equipment!

Improper positioning of the round cable clamps can lead to damage of the cables and festoon system. Improper mounting and arrangement of cables in the round cable clamp can damage the cables and the cable trolley system.

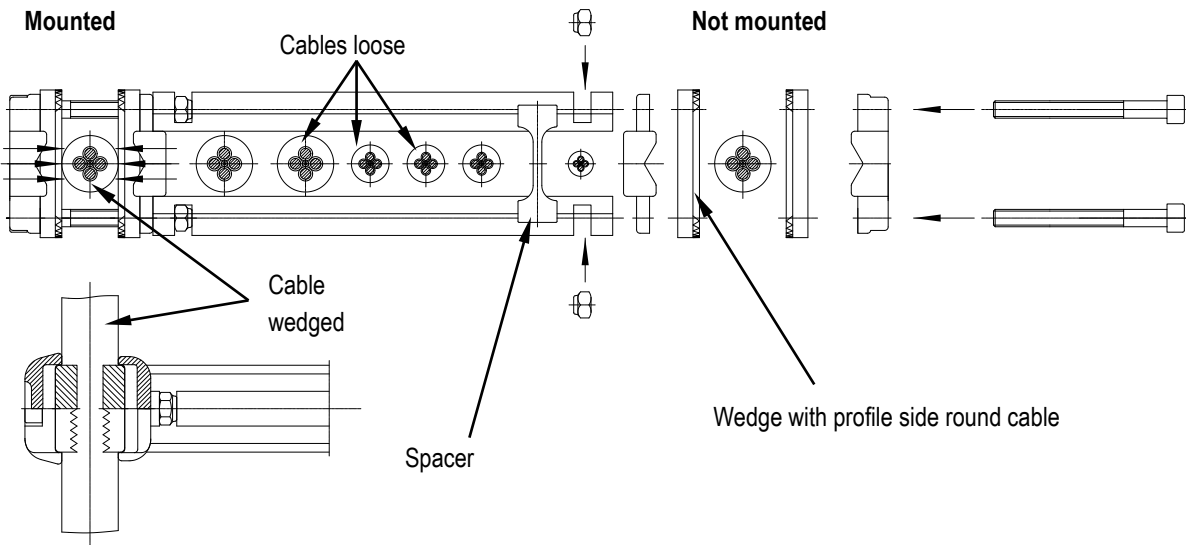

Fig. 42: Mounting round cable clamps



ATTENTION!

It is recommended that the round cable clamps be preassembled as shown in this diagram in order to maintain two identical halves.

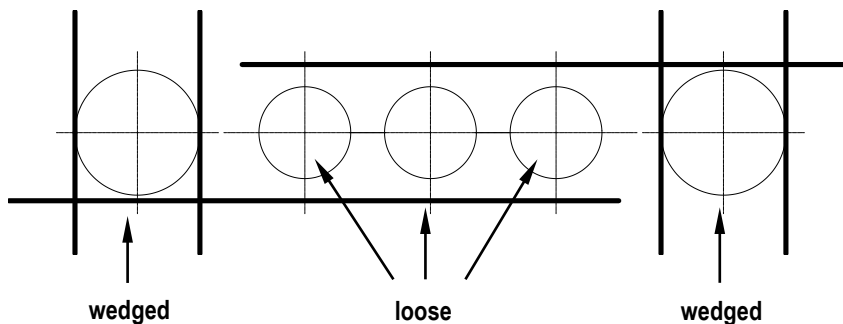

Fig. 43: Schematic diagram of preparation for installation of round cable clamps

Festoon systems for C-rails

Program 0230 / 0240 / 0250 / 0255 / 0260

The outer left and right cables are firmly wedged between the rubber profiles.

Ensure that the inner cables can move freely in the round cable clamp window.

If spacers need to be used (in order to prevent turning and superimposition of cables), insert them before closing the cable clamp. The use of spacers depends on the diameter of the cables. The cable clamp screws must be lubricated. For example, Klüber MR-401. Screws must be tightened crosswise.



ATTENTION!

Spacers:

Improper positioning or removal of spacers in round cable clamps can cause damage to the cables or the cable trolley system.

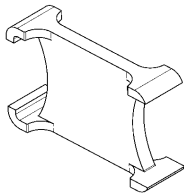

Fig. 44.: Spacer

6.3.9 Installing flat cable clamps



ATTENTION!

Clamp the uppermost cables in the flat cable clamp. The other cables must be freely movable in the flat cable clamp window.



CAUTION!

Damage to the cables and the cable-festoon equipment!

Improper positioning of the flat cable clamps can lead to damage of the cables and festoon system. Improper mounting and arrangement of cables in the flat cable clamp can damage the cables and the festoon system.

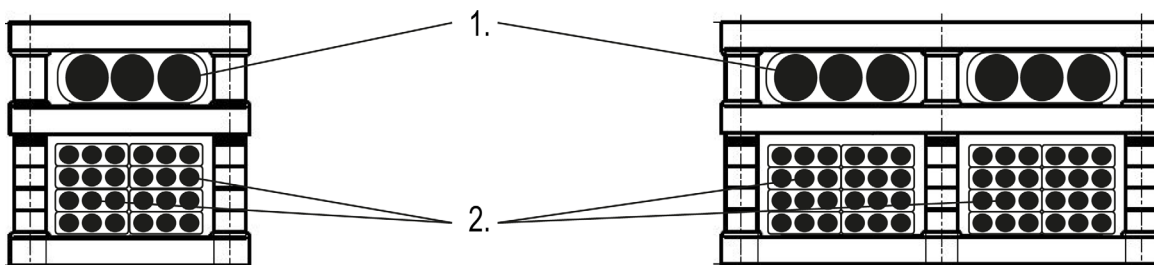

1. = Main power cable clamped

2. = Control line with play in window

Fig. 45: Installing flat cable clamps

Festoon systems for C-rails

Program 0230 / 0240 / 0250 / 0255 / 0260

The arrangement of the spacers allows for the height of the flat cable clamp to be adapted to the cable package.

The window for the control cable is to be adjusted so that the cables of the block have enough play (> 5 mm) in the window. The cable clamp screws must be lubricated.

6.3.10 Mounting the towing rope

The towing rope is installed between two cable trolleys, end clamps, and cable trolley, or between a towing trolley and a cable trolley. Ensure that the shackles can be easily moved after tightening the retaining nut. The shackles must be serviced at regular intervals (The shackles must be serviced at regular intervals (see Section 8)).



ATTENTION!

- Ensure that the shackles and thimbles can be freely moved after installation.
- For the 0230/0240 line of festoon systems, the installation of an additional eye between the end clamp and end stop is necessary for the fastening of the towing rope.

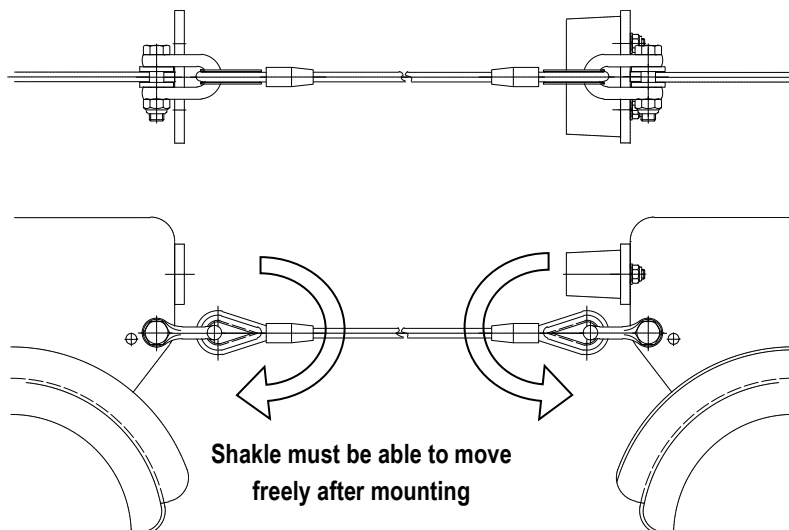

Fig.46: Towing rope

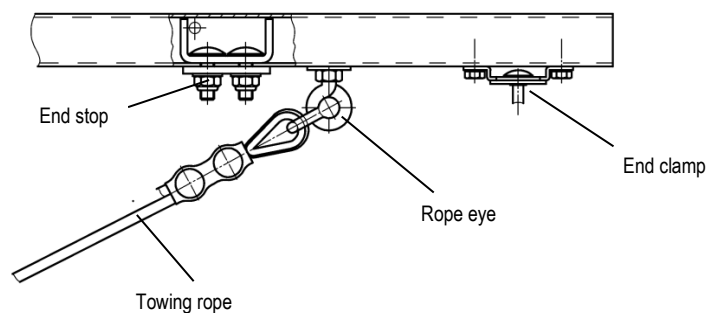

Fig. 47: Eye with towing rope

Festoon systems for C-rails

Program 0230 / 0240 / 0250 / 0255 / 0260

6.3.11 Damping device

The damping device is installed between two cable trolleys, end clamps, and cable trolley, or between a towing trolley and a cable trolley. Be sure that the fastening eyes can still move slightly after tightening of the lock nut, or in the case of slack shock cords, can tip over alone.



ATTENTION!

Be sure that the fastening eyes can still move slightly after tightening of the lock nut, or in the case of slack shock cords, can tip over alone.



CAUTION!

Risk of injury

When entering systems with damping devices, the load on them must first be released.

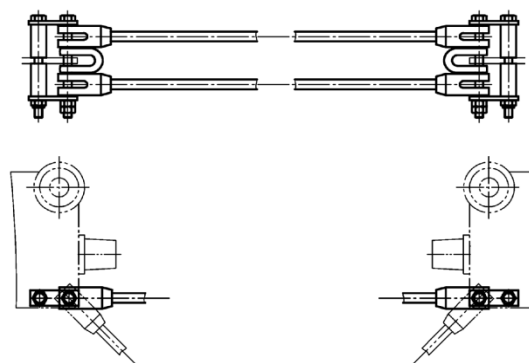

Fig. 48: Damping device

6.4 Testing and commissioning



WARNING!

Danger of injury due to improper commissioning!

Improperly performed commissioning can lead to dangerous situations for personnel.

- Before commissioning, carry out the tests in the test list of the manufacturer.
- Never start the festoon system without testing according to the manufacturer's test list.
- Before commissioning, perform a visual check and carry out the prescribed tests.
- Any procedures that could threaten safety are to be avoided.
- Notify the responsible person immediately of any damage to the festoon system.
- The festoon system should only be operated with functional protective gear and safety devices.
- It is forbidden to enter the operating area of the festoon system.

Festoon systems for C-rails

Program 0230 / 0240 / 0250 / 0255 / 0260



CAUTION!

Danger of tripping on projecting parts!

When working on the festoon system, there is a risk of tripping.

- When walking in the work and danger area, be careful of projections and depressions in the floor. No loose objects may be left on the floor.



WARNING!

Danger of crushing!

When moving the festoon system, there is a danger of crushing limbs between the buffer and buffer plate, as well as between the carriage and the track carrier.

- When the system is moving, do not enter the danger area of the festoon system.



CAUTION!

Danger of being trapped!

When the festoon system is moving, there is a danger of being trapped within it.

- When the system is moving, do not enter the danger area of the festoon system.



DANGER!

Danger of injury due to electrocution!

Danger of severe injury or death due to electric current.

- Before working on the cable-festoon system, the system must be disconnected from power using the main switch, and secured against unauthorized, unintentional, and/or erroneous activation. In special cases where there is no main switch, the power disconnection must be carried out according to the specifications of the system manufacturer. Check that parts disconnected from power are voltage free, then ground and short-circuit them. Insulate adjacent live parts!
- Before each commissioning, the crane manufacturer must perform an insulation test, in accordance with the local technical standards, regulations and laws, for the complete system in which the cable-festoon system is installed



CAUTION!

Risk of injury due to slipping and falling!

There is a risk of injury due to a dangerous environment or difficult installation conditions. For example, near cranes, in difficult-to-access locations, etc.

- Use personal protective equipment (protective gloves, safety helmet, safety shoes)
- Keep the location tidy
- Use only secure scaffolding
- Take appropriate safety measures

The festoon system is commissioned together with the system operator and is documented. All necessary personnel for commissioning including operators, electricians and installation technicians are to be provided by the system operator for the course of commissioning. Free access to the system must be provided. After commissioning is complete, Conductix-Wamplfer will receive an authorized final acceptance protocol from the operator, in which it is logged that the system corresponds to the requirements.

Installation instructions

Festoon systems for C-rails

Program 0230 / 0240 / 0250 / 0255 / 0260

Commissioning check list

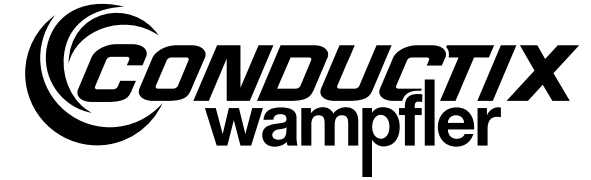

6.4.1 Commissioning test list



CAUTION!

This checklist should be used as a guideline to ensure the safety operation of the festoon system. The operating instructions are intended for qualified specialists who install the festoon systems, operate them and who are familiar with the requirements regarding work safety and accident prevention.

If Conductix-Wampfler performed the commissioning, the final acceptance protocol on the last page should be filled out.

Customer:		Cust. No.:	
		Order No.:	
Customer:		Order No.:	
Commissioning location:		Zip Code:	
Address:		Country:	
Name of system:			
Start of commissioning:		Commissioner	
Ending of commissioning:		Name:	
		Date:	
		Signature:	

Installation instructions

Festoon systems for C-rails

Program 0230 / 0240 / 0250 / 0255 / 0260

Commissioning check list

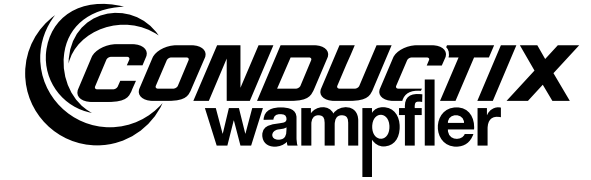

Inspections on deactivated system		OK	Not OK
A01	The track of the consumer corresponds to the project-specific technical documentation.	<input type="checkbox"/>	<input type="checkbox"/>
A02	The storage length of the festoon system corresponds to the project-specific technical documentation.	<input type="checkbox"/>	<input type="checkbox"/>
A03	All screws have a sufficient length and are secured. The projecting ends of the screws are visible (at least 2 thread projection).	<input type="checkbox"/>	<input type="checkbox"/>
A04	The towing arm is mounted in the middle of the window of the towing trolley and has play in all dimensions.	<input type="checkbox"/>	<input type="checkbox"/>
A05	Cables are to be arranged according to specifications in the cable arrangement recommendation (see project-specific technical documentation).	<input type="checkbox"/>	<input type="checkbox"/>
A06	Loop lengths of the cables correspond to the specifications of the project-specific technical documentation. The permissible length deviation is ±50 mm .	Actual _____	<input type="checkbox"/>
A07	Cables are arranged free of twists	<input type="checkbox"/>	<input type="checkbox"/>
A08	Cables show <u>no</u> damage caused by transport or assembly.	<input type="checkbox"/>	<input type="checkbox"/>
A09	The cables are mounted on the supports in such a way that the cable trolleys run horizontally on the track profile (balance of the cables on the right and left supports). Cable clamps firmly tightened so that cables cannot be pulled out manually, but still with enough play that the cables are also not crushed.	<input type="checkbox"/>	<input type="checkbox"/>
A10	Cable ends (installation lengths) are arranged with sufficient strain relief and the right length to the end or towing side.	<input type="checkbox"/>	<input type="checkbox"/>
A11	Cable clamps (round and flat cable clamps) are mounted in the loops at the same height, corresponding to the project-specific documentation (system sketch) with the necessary displacement. The permissible height deviation is ±150 mm .	Actual _____	<input type="checkbox"/>

Installation instructions

Festoon systems for C-rails

Program 0230 / 0240 / 0250 / 0255 / 0260

Commissioning check list

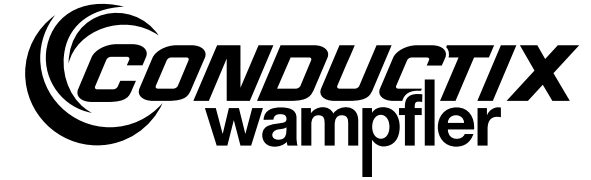

Inspections on deactivated system		OK	Not OK
A12	Special component parts such as spacers, additional clamp pieces and guide rings are to be mounted according to the project-specific technical documentation.	<input type="checkbox"/>	<input type="checkbox"/>
A13	The length of the installed towing ropes for each cable loop corresponds to the project-specific technical documentation. The permissible length deviation is ±50 mm .	<input type="checkbox"/>	<input type="checkbox"/>
A14	Ensure that the shackles for fastening the towing rope can be freely moved after installation and lubrication.	<input type="checkbox"/>	<input type="checkbox"/>
A15	The towing rope and rubber robe show <u>no</u> damage caused by transport or assembly.	<input type="checkbox"/>	<input type="checkbox"/>
A16	The number of shock cords used for each cable loop corresponds to the project-specific technical documentation.	<input type="checkbox"/>	<input type="checkbox"/>
A17	The length of shock cords used for each cable loop corresponds to the project-specific technical documentation. The permissible length deviation is ±50 mm .	<input type="checkbox"/>	<input type="checkbox"/>
A18	The towing rope and shock cords are mounted free of twists.	<input type="checkbox"/>	<input type="checkbox"/>
A19	Check steel structure for collision-free travel of the festoon system. No catching, intertwining of the cables, towing ropes and shock cords.	<input type="checkbox"/>	<input type="checkbox"/>
A20	The track profile for the festoon system in alignment to the crane carrier is mounted straight according to the tolerance requirements.	<input type="checkbox"/>	<input type="checkbox"/>
A21	Joints of the track carrier have no height and side offset	<input type="checkbox"/>	<input type="checkbox"/>
A22	The corrosion protection is undamaged and intact.	<input type="checkbox"/>	<input type="checkbox"/>

Installation instructions

Festoon systems for C-rails

Program 0230 / 0240 / 0250 / 0255 / 0260

Commissioning check list



Inspections on running systems with 10% consumer running speed:		OK	Not OK
Forward direction from the trolley storage / end clamp side towards the towing side until the cable tow is completely wound up. Backward direction from the towing side towards the trolley storage / end clamp side up to the end position.			
B01	Horizontal alignment gap between the cable trolley and the crane construction is wide enough that no collision can take place with cable trolleys or their components.	<input type="checkbox"/>	<input type="checkbox"/>
B02	Check of the loop lengths at the maximum pulled out festoon system corresponds to the project-specific technical documentation.	<input type="checkbox"/>	<input type="checkbox"/>
Inspections on running systems with 50% consumer running speed:		OK	Not OK
Forward direction from the trolley storage / end clamp side towards the towing side until the cable tow is completely wound up. Backward direction from the towing side towards the trolley storage / end clamp side up to the end position.			
C01	Horizontal alignment gap between the cable trolley and the crane construction is wide enough that no collision can take place with cable trolleys or their components.	<input type="checkbox"/>	<input type="checkbox"/>
C02	Check of the loop lengths at the maximum pulled out festoon system corresponds to the project-specific technical documentation.	<input type="checkbox"/>	<input type="checkbox"/>
Inspections on running systems with 100% consumer running speed:		OK	Not OK
Forward direction from the trolley storage / end clamp side towards the towing side until the cable tow is completely wound up. Backward direction from the towing side towards the trolley storage / end clamp side up to the end position.			
D01	Horizontal alignment gap between the cable trolley and the crane construction is wide enough that no collision can take place with cable trolleys or their components.	<input type="checkbox"/>	<input type="checkbox"/>
D02	Check of the loop lengths at the maximum pulled out festoon system corresponds to the project-specific technical documentation.	<input type="checkbox"/>	<input type="checkbox"/>

Installation instructions
Festoon systems for C-rails

Program 0230 / 0240 / 0250 / 0255 / 0260

Commissioning check list

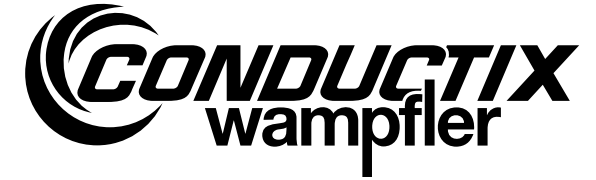

Inspections on running systems in mode over 30 minutes.		OK	Not OK
E01	Horizontal alignment gap between the cable trolley and the crane construction is wide enough that no collision can take place with cable trolleys or their components.	<input type="checkbox"/>	<input type="checkbox"/>
E02	Check of the loop lengths at the maximum pulled out festoon system corresponds to the project-specific technical documentation.	<input type="checkbox"/>	<input type="checkbox"/>
Documentation			
F01	Project-specific documentation is available and complete at the customer's facility, along with technical data, system diagrams, cable layout suggestion, and round/flat cable terminal layouts.	<input type="checkbox"/>	<input type="checkbox"/>

Festoon systems for C-rails

Program 0230 / 0240 / 0250 / 0255 / 0260

7 Operation

7.1 Safety



WARNING!

Danger of death due to hanging loads!

When lifting loads, there is a danger of death from falling parts or those swinging out of control.

- Never step under hanging loads.
- Block off the dangerous area under the system.
- Move loads only under supervision.
- Follow the specifications for the attachment points provided.
- Do not attach to projecting machine parts or to eyes on installed components. Be sure the connection elements are firmly seated.
- Use only authorized lifting accessories and connection elements with sufficient load capacity.
- Do not use torn or worn ropes or straps.

Do not attach ropes or straps to sharp corners and edges, and do not knot or twist them.

- Set down the load when leaving the workplace.



WARNING!

Danger of injury due to improper operation!

Improper operation can result in serious injury to person and property.

- Perform all operating steps according to the specifications of this installation manual
- Before starting work, be sure that all covers and safety systems are installed and working properly.
- Never disable the safety systems during operation.
- Maintain order and cleanliness in the working area! Loosely stacked or scattered components and tools are a source of accidents.



WARNING!

Danger for unauthorized personnel!

Unauthorized personnel who do not meet the requirements described here do not understand the danger in the work area.

- Keep unauthorized personnel away from the work area.
- In case of doubt, address personnel and warn them away from the work area.
- Cease working as long as unauthorized personnel are present in the work area.



CAUTION!

Danger of tripping on projecting parts!

When working on the festoon system, there is a risk of tripping.

- When walking in the work and danger area, be careful of projections and depressions in the floor. No loose objects may be left on the floor.



WARNING!

Danger of crushing!

When the festoons move, there is a risk of crushing hands between two festoons or between a festoon and an end stop.

- The customer must cordon off the danger area of the system or have it installed in an inaccessible area
- Use personal protective equipment (protective gloves, safety helmet, safety shoes)

Festoon systems for C-rails

Program 0230 / 0240 / 0250 / 0255 / 0260



DANGER!

Danger of being trapped!

When the festoon system is moving, there is a danger of being trapped within it.

- When the system is moving, do not enter the traveling area of the festoon system.
- The customer must cordon off the danger area of the system



DANGER!

Risk of injury due to falling objects!

There is a risk due to falling parts in case of improper use (incorrect assembly, misuse, lack of maintenance).

- Perform maintenance on a regular basis!



DANGER!

Danger of injury due to electrocution!

Danger of severe injury or death due to electric current.

- The system engineer/operator must ensure that no projecting contours near the cable-festoon system are able to damage the cables
- Regularly check cables for wear
- Before working on the cable-festoon system, the system must be disconnected from power using the main switch, and secured against unauthorized, unintentional, and/or erroneous activation. In special cases where there is no main switch, the power disconnection must be carried out according to the specifications of the system manufacturer. Check that parts disconnected from power are voltage free, then ground and short-circuit them. Insulate adjacent live parts!
- Before each commissioning, the crane manufacturer must perform an insulation test, in accordance with the local technical standards, regulations and laws, for the complete system in which the cable-festoon system is installed
- Provide electrical protection measures in accordance with the regulations for the system



DANGER!

Risk of burns!

Burns can be caused by:

- Live components
- Overload
- Components that have become live due to a fault
- Short circuits

Remedial measures:

- Do not overload the cables!
- System engineers must design the dimensioning and protective electrical devices in accordance with the permissible load capacity of the cables
- Connections may only be made by specialist electricians



WARNING!

Risk of fire!

Risk of fire if undersized cables are used!

- Do not overload the cables
- The required cable cross-sections must be adhered to
- System engineers must design the dimensioning and protective electrical devices in accordance with the permissible load capacity of the cables
- Connections may only be made by specialist electricians

Festoon systems for C-rails

Program 0230 / 0240 / 0250 / 0255 / 0260



WARNING!

Unsafe operation of the system!

Falling system components due to installation errors!

- Do not stay in the danger zone under the system
- Comply with the maximum load and speed limits
- After completing the installation, perform a test run of the system only at low speed
- Check the system in accordance with the maintenance plan and perform regular maintenance



WARNING!

Breakage during operation due to an installation error!

Breakage of a load bearing roller axle and other cable-festoon components or the track suspension can be caused by installation errors!

- Do not stay in the danger zone under the system
- Comply with the maximum load and speed limits
- Check the system in accordance with the maintenance plan and perform regular maintenance

Personnel:

- The system may only be operated by trained personnel!

7.2 Function

A towing arm couples the towing trolley to the mobile consumer. The towing trolley pulls and/or pushes the following cable trolley. The cables are held on the supports with clamping strips. For improved shock absorption when trolleys meet, buffers are placed on the festoon system. Depending on the project, tension relief cable, shock cord, and round or flat cable clamps and guide rings may also be used.

The dimensions of the festoon system can be found in the project-specific dimension sheet.

The system is to be checked for changes in running noise and irregularities during operation.

If irregularities are determined during operation, then the system is to be stopped immediately. The cause of the fault is to be determined using the fault table (see Section 9).

The fault table includes the causes for the disturbance as well as the recommendations for their remedy. If the cause cannot be determined or if there is no way to repair the system with the company's resources, then we recommend that you request a service technician from our customer service.

Festoon systems for C-rails

Program 0230 / 0240 / 0250 / 0255 / 0260

8 Maintenance and service

8.1 Safety



WARNING!

Danger of injury due to improperly executed maintenance tasks!

Improper maintenance can result in serious injury to person and property.

- Before starting work, ensure sufficient space for assembly.
- Maintain order and cleanliness in the assembly area! Loosely stacked or scattered components and tools are a source of accidents.
- If components have been removed, be careful to reinstall them properly, replace all fastening elements, and comply with screw tightening torques.



WARNING!

Danger of injury from moving components!

Incautious handling of the festoon system can lead to severe injury or damage to the festoon system.

- Be sure that the festoon system does not start by itself.
- While it is moving, do not reach into moving parts, particularly the interface between the buffer and buffer plate.
- Block off the dangerous area under the system.



CAUTION!

Danger of tripping on projecting parts!

When working on the festoon system, there is a risk of tripping.

- When walking in the work and danger area, be careful of projections and depressions in the floor. No loose objects may be left on the floor.



WARNING!

Danger of crushing!

On complete installation of the cable-festoon system, there is a risk of crushing extremities between load carriers and track profiles.

When moving the festoon system, there is a danger of crushing limbs between the buffer and buffer plate, as well as between the carriage and the rail profile.

There is a risk of crushing of the hands when moving the C-rail into the rail connector/hanger clamp.

- Do not enter the danger area of the cable-festoon system when the system is moving or during assembly.
- Use personal protective equipment (protective gloves, safety helmet, safety shoes) when moving the C-rail



DANGER!

Danger of being trapped!

When the festoon system is moving, there is a danger of being trapped within it.

- When the system is moving, do not enter the danger area of the festoon system.
- The customer must cordon off the danger area of the system
- Before starting work, shut down the system and secure it against accidental start

Festoon systems for C-rails

Program 0230 / 0240 / 0250 / 0255 / 0260



DANGER!

Risk of injury due to falling parts!

There is a risk due to falling parts in case of improper use (incorrect assembly, lack of attention).

- Cordon off a generous area underneath the system!
- Keep the time specialist fitters spend in the danger area to a minimum
- Wear a safety helmet!



DANGER!

Risk of burns!

Burns can be caused by:

- Live components
- Overload
- Components that have become live due to a fault
- Short circuits

Remedial measures:

- Do not overload the cables!
- System engineers must design the dimensioning and protective electrical devices in accordance with the permissible load capacity of the cables
- Connections may only be made by specialist electricians



DANGER!

Danger of injury due to electrocution!

Danger of severe injury or death due to electric current.

- The system engineer/operator must ensure that no projecting contours near the cable-festoon system are able to damage the cables
- Regularly check cables for wear
- Before working on the cable-festoon system, the system must be disconnected from power using the main switch, and secured against unauthorized, unintentional, and/or erroneous activation. In special cases where there is no main switch, the power disconnection must be carried out according to the specifications of the system manufacturer. Check that parts disconnected from power are voltage free, then ground and short-circuit them. Insulate adjacent live parts!
- Before each commissioning, the crane manufacturer must perform an insulation test, in accordance with the local technical standards, regulations and laws, for the complete system in which the cable-festoon system is installed
- Provide electrical protection measures in accordance with the regulations for the system



WARNING!

Risk of fire!

Risk of fire if undersized cables are used!

- Do not overload the cables
- The required cable cross-sections must be adhered to
- System engineers must design the dimensioning and protective electrical devices in accordance with the permissible load capacity of the cables
- Connections may only be made by specialist electricians

Festoon systems for C-rails

Program 0230 / 0240 / 0250 / 0255 / 0260



CAUTION!

Risk of injury due to slipping and falling!

There is a risk of injury due to a dangerous environment or difficult installation conditions. For example, near cranes, in difficult-to-access locations, etc.

- Use personal protective equipment (protective gloves, safety helmet, safety shoes)
- Keep the location tidy
- Use only secure scaffolding
- Take appropriate safety measures

8.2 Maintenance/inspection plan

The next sections describe the maintenance tasks required for optimum, trouble-free operation. If regular inspections reveal increased wear, the corresponding maintenance intervals should be shortened in accordance with the actual signs of wear. Contact the manufacturer with any questions about maintenance tasks or intervals.

In order to retain the warranty rights and to avoid damage, the system operator is responsible for performing the following maintenance tasks. Inspection, service and repair are to be performed and documented by trained and qualified specialists.



ATTENTION!

The intervals indicated for maintenance are dependent for the most part on operational conditions of the festoon system. Therefore only mean values can be indicated here.

The following tasks fall under the category "Maintenance":

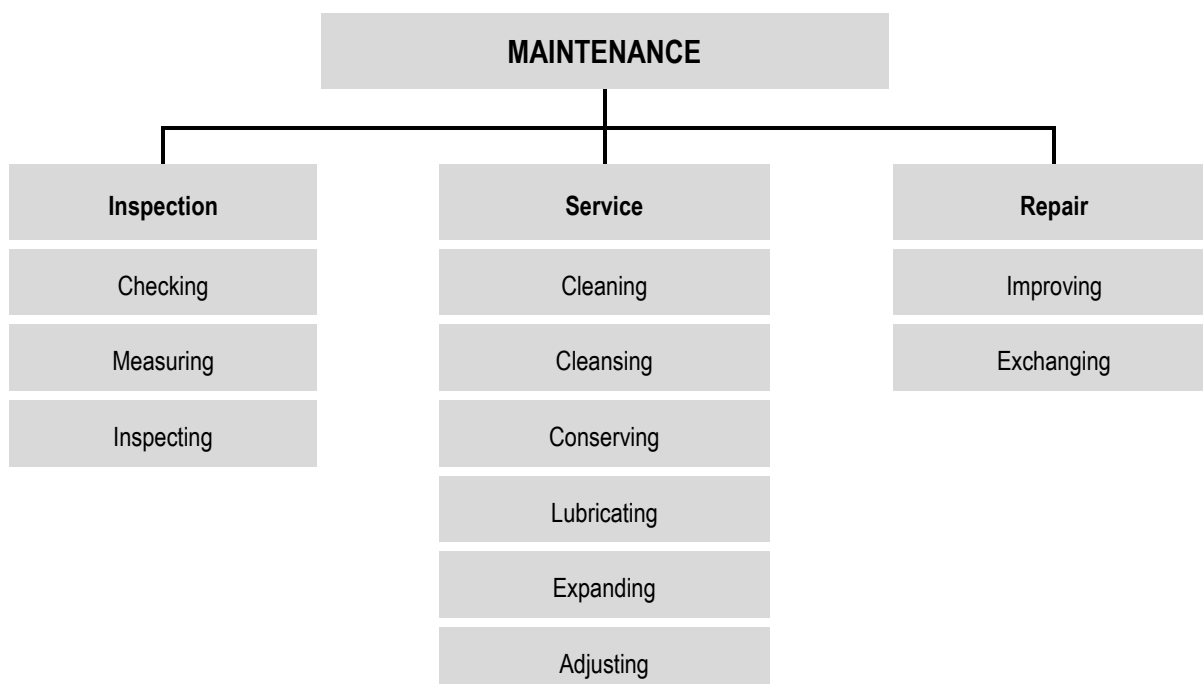

Festoon systems for C-rails

Program 0230 / 0240 / 0250 / 0255 / 0260

8.2.1 Inspection on deactivated system



CAUTION!

- Protect the festoon system from inadvertent activation.
- Safety devices that were removed during inspection of the resting system must be immediately remounted and checked after completion of work.
- Check measuring tools used after clean up/ collection and inventory.
- Before approaching systems with damping devices, they must first be released.

Inspection measures

Interval	Component	Task Description	Description
Every 14 days: 3 and 4 shift operation at the latest after 300 operational hours Every 30 days: 2 shift operation at the latest after 300 operational hours	Rollers	Visual inspection	- for proper condition
	Buffers		- for proper function
	Center plate		- for proper mobility
	Cable supports		- for firm seating
	Fasteners		- for deformations
	Cables		- for wear
	Cable clamps		- for damages
	Fixed installation length		- for dirt
	Installation connections		- for corrosion
	Towing ropes		
	Damping device		
	Towing devices		
	End stops		
	Track profile		

Festoon systems for C-rails

Program 0230 / 0240 / 0250 / 0255 / 0260

8.2.2 Inspection of towing rope and criteria for replacement



ATTENTION!

- Towing ropes must be inspected at regular intervals.
- The inspections must be performed at least every 12 months.



CAUTION!

In case of defect, towing ropes must be removed from use immediately. They must be replaced.

A stress-relieving cable must be taken out of service (replaced) if one or more of the following criteria is met:

1. Wire breakage
2. Structural changes
3. Corrosion
4. Abrasion

The following steel cable deformations are leading to a necessary replacement:

- Corkscrew-like deformation: Replace the cable if it has corkscrew deformations with waves that measure more than a third of the cable diameter.
- Fraying: Replace the cable if it starts to fray.
- Loop formation: Replace the cable if loop formation has led to significant changes in the cable structure.
- Loosening: Replace if wires are loosened due to rust or abrasion.
- Node formation: Replace if nodes- points where the cable is widened- form in the steel cable.
- Constrictions: Replace in case of severe constrictions in the cable.
- Curling: Replace the towing rope if permanent deformations are present such as those caused by being pulled over a corner.
- Kinks: Replace if kinks form after tension is applied to cable loops.
- Bends: Replace the towing rope if it has been bent by an external force.

Festoon systems for C-rails

Program 0230 / 0240 / 0250 / 0255 / 0260

8.2.3 Inspection on moving system



CAUTION!

- Any procedures that could threaten safety are to be avoided.
- The system should only be commissioned with functional protective gear and safety devices.
- It is forbidden to enter the operating area of the festoon system.

Inspection measures

Interval	Component	Task Description	Description
Every 14 days: 3 and 4 shift operation at the latest after 300 operational hours Every 30 days: 2 shift operation at the latest after 300 operational hours	Rollers	Function Test	For easy and unobstructed running of the main rollers, horizontal guide rollers and anti-lift rollers on the on the track profile. Visible wear, damage.
	Cable trolley		For proper entry and exit of the cable trolleys in the storage area
	Towing device		For reliable operation of the towing device based on the required horizontal and vertical balancing movements.
	Buffer unit towing or end clamp		For functionality of the damping device, especially when the system is in the storage.
	Towing rope Damping devices		For functionality of the towing ropes and damping devices, especially when the system is completely extended.
	Track profile and system		Of the track beam and the entire system, for dirt and corrosion that influence functionality.

Should problems be identified during inspection, service work is urgent.

8.2.4 Logging

The results of inspections as well as the remedies performed are to be documented in written reports. Conductix-Wampfler must be informed immediately of defects and malfunctions during the test phase and the warranty period.

Festoon systems for C-rails

Program 0230 / 0240 / 0250 / 0255 / 0260

8.2.5 Maintenance of the festoon system



CAUTION!

Be careful when servicing the cable-festoon system!

- Turn off power supply and ensure that no inadvertent activation is possible.
- When installation tasks are carried out above eye level, use proper climbing aids and working platforms.
- Do not use machine components as climbing aids.
- Ensure that exhaust, collection and disposal of process materials is done in a safe and environmentally-friendly manner.
- Safety devices that were removed for installation, service or repair must be immediately remounted and inspected after work is completed.
- Observe the inspection and maintenance intervals described in the maintenance instructions.
- Ensure that sufficient space for maintenance work (danger area) is available.
- Ensure that the festoon system is not inadvertently activated during maintenance work.
- Ensure that detached parts do not fall.
- Screw joints that are disconnected during maintenance work are to be reattached (with suitable torque) and secured as instructed.
- Fasteners and seals that cannot be reused are to be replaced (such as self-locking nuts, disks, splints, O-rings, glued or microencapsulated screws).
- Lubrication points that are cleaned or wiped during maintenance and repair work must be re-lubricated as instructed.
- After finishing work, collect all tools and materials and check that all are present.
- Disassembled parts and components that were exchanged are to be collected, stored in a safe place, recycled and sent back.
- Before approaching systems with damping devices, these must be released.

Festoon systems for C-rails

Program 0230 / 0240 / 0250 / 0255 / 0260

Service measures

Interval	Component	Task Description	Description
Every 14 days: 3 and 4 shift operation at the latest after 300 operational hours Every 30 days: 2 shift operation at the latest after 300 operational hours	Roller mounting	Service performed	Tighten all fasteners.
	Cable mounting		Tighten all fasteners on clamping bars and cable clamps.
	Towing device		Exchange worn parts if necessary.
	Damping device		Exchange shock cords if necessary.
Every 3 months	Towing rope		Tighten mounting screws. Lubricate the contact surfaces of the shackles.
	Buffer unit towing or end clamp		Tighten all fasteners. Exchange worn parts if necessary.
Annually (depends on external influences)	Surface/ corrosion protection Corrosion coating		repair / replace

Festoon systems for C-rails

Program 0230 / 0240 / 0250 / 0255 / 0260

8.2.6 Wearing parts

Wearing parts are excluded from the warranty. This includes:

- All trolley rollers including main rollers, horizontal guide rollers, counter-pressure rollers
- Cable (expander and/or shock cord) on the damping devices.
- Special damping systems in the towing arm window
- Rubber or cellular buffers
- Other definitions require written documentation.

8.2.7 Wear limits

Component	Wear limit has been reached if
Rollers	<ul style="list-style-type: none"> → the diameter of the roller has been reduced from the nominal diameter by 2 mm → sharp impressions can be seen → cracks, broken-off pieces, or embrittlements have formed on Vulkollan or Adiprene rollers or if initial signs that the outer section is disengaging from the core appear → increased bearing play occurs due to worn ball bearings → significant lubrication leakage is seen → the rollers do not run smoothly
Buffers	→ cracks, breaks or embrittlements are seen
Center sheets and side plates	→ corrosion protection has failed
Cable supports	<ul style="list-style-type: none"> → corrosion protection has failed → initial signs of cracks in the supports are seen
Fasteners	<ul style="list-style-type: none"> → corrosion protection has failed → connection integrity (screw joints, clamp connections, glued connections) is no longer ensured
Cables	<ul style="list-style-type: none"> → wire, shielding or jacket breakage is seen → corkscrews have formed
Cable clamps	<ul style="list-style-type: none"> → corrosion protection has failed → cracks and embrittlements are seen in the clamp rubber → the clamp does not hold cables sufficiently
Towing rope	→ wires break, structural changes occur, corrosion and abrasion
Towing devices	<ul style="list-style-type: none"> → corrosion protection has failed → the towing arm window is deformed → cracks in the welding joints appear

Festoon systems for C-rails

Program 0230 / 0240 / 0250 / 0255 / 0260

Component	Wear limit has been reached if
End clamp	<ul style="list-style-type: none"> → corrosion protection has failed → attachment to the track profile is no longer secure
Damping systems and shock cords	<ul style="list-style-type: none"> → corrosion protection has failed → severe constrictions in the shock cords occur → the mantle of the shock cord is even partially torn → fraying strands on the shock cord appear → mechanical deformations appear on the shock cord brackets
Track profile	<ul style="list-style-type: none"> → corrosion protection has failed → significant tracks from the rollers of the cable trolley system appear

8.2.8 Repeat inspections



ATTENTION!

Devices and systems are to be periodically inspected by an expert. In general, visual and functional checks are to be performed. The condition of components with regard to damage, wear, corrosion or other damage is to be determined. Generally speaking, the completeness and functionality of the safety equipment is evaluated. To better evaluate the wear and tear of parts, disassembly may be required.

All regular inspections are to be performed by the operator.

Every operator is to record all inspection, service and maintenance tasks in a machine book in an orderly manner. This is to be confirmed by a technical expert. In case of inaccurate or missing entries, the warranty is rendered null and void.

8.2.9 Repair

Request a customer service technician from Conductix-Wampfler for all repairs.

If the operator's qualified specialist personnel carry out repairs themselves, they must follow the instructions in this installation manual to the letter.

Conductix-Wampfler accepts no liability or provide warranty for damages and production faults resulting from failure to comply with this installation manual.

For maintenance and repair, only use

- suitable tools in good working order
- only original replacement parts from Conductix-Wampfler or replacement parts explicitly authorized by Conductix-Wampfler.

Festoon systems for C-rails

Program 0230 / 0240 / 0250 / 0255 / 0260

9 Troubleshooting



WARNING!

Danger of injury due to improper troubleshooting!

Improper troubleshooting can result in serious injury to person and property.

- Contact the manufacturer in case of malfunction.
- Allow troubleshooting to be carried out only by personnel from or authorized by the manufacturer.



CAUTION!

Improper use can result in serious injury to person and property.

- Elimination of faults may only be performed by qualified specialists.

Faults	Cause	Solution
Towing rope torn	Overstress Wear ¹⁾	Exchange towing rope
Shock cord torn	Overstress Wear ¹⁾	Exchange shock cord
Buffer is defective	Overstress Wear ¹⁾	Exchange buffer
Roller function impaired	Overstress Wear ¹⁾	Exchange roller
Noticeable mechanical strain of the components (bending, tear, wear)	Malfunction ²⁾	Exchange the corresponding component

¹⁾ The cause of overstress must be identified and corrected.

²⁾ If injury to person and property can occur during breakdowns then Conductix-Wampfler must be informed immediately.

Festoon systems for C-rails

Program 0230 / 0240 / 0250 / 0255 / 0260

10 Disassembly and disposal

10.1 Safety



Danger of injury due to electrocution!

Danger of severe injury or death due to electric current.

- Before working on the cable-festoon system, the system must be disconnected from power using the main switch, and secured against unauthorized, unintentional, and/or erroneous activation. In special cases where there is no main switch, the power disconnection must be carried out according to the specifications of the system manufacturer. Check that parts disconnected from power are voltage free, then ground and short-circuit them. Insulate adjacent live parts!
- Provide electrical protection measures in accordance with the regulations for the system



Danger of injury due to improper disassembly!

Stored energy, sharp components, points, and edges on and in the festoon system or the tools needed can cause injury.

- Before starting work, ensure sufficient space.
- Handle open, sharp-edges components carefully.
- Maintain order and cleanliness in the work area! Loosely stacked or scattered components and tools are a source of accidents.
- Dismount components properly. Note the high weight of some components. If necessary, use lifting gear.
- Secure components so that they cannot fall or fall over.
- Involve the manufacturer in case of any unclear points.



Danger of injury from moving components!

Incautious handling of the festoon system can lead to severe injury or damage to the festoon system.

- Be sure that the festoon system does not start by itself.
- While it is moving, do not reach into moving parts, particularly the interface between the buffer and buffer plate.
- Block off the dangerous area under the system.



Danger of tripping on projecting parts!

When working on the festoon system, there is a risk of tripping.

- When walking in the work and danger area, be careful of projections and depressions in the floor. No loose objects may be left on the floor.

Festoon systems for C-rails

Program 0230 / 0240 / 0250 / 0255 / 0260



WARNING!

Danger of crushing!

When disassembling the cable-festoon system, there is a risk of crushing extremities between load carriers and track profiles.

When moving the cable-festoon system, there is a danger of crushing extremities between the buffer and buffer plate, as well as between the carriage and track profiles.

There is a risk of crushing of the hands when moving the C-rail into the rail connector/hanger clamp.

- Do not enter the danger area of the cable-festoon system when the system is moving or during assembly
- Use personal protective equipment (protective gloves, safety helmet, safety shoes) when moving the C-rail



DANGER!

Danger of being trapped!

There is a danger of being trapped when the cable-festoon system is moving.

- Do not enter the danger area of the cable-festoon system when the system is moving
- The customer must cordon off the danger area of the system
- Before starting work, shut down the system and secure it against accidental start



DANGER!

Risk of injury due to falling parts!

There is a risk due to falling parts in case of improper use (incorrect assembly, lack of attention).

- Cordon off a generous area underneath the system!
- Keep the time specialist fitters spend in the danger area to a minimum
- Wear a safety helmet!



CAUTION!

Risk of injury due to slipping and falling!

There is a risk of injury due to a dangerous environment or difficult installation conditions. For example, near cranes, in difficult-to-access locations, etc.

- Use personal protective equipment (protective gloves, safety helmet, safety shoes)
- Keep the location tidy
- Use only secure scaffolding
- Take appropriate safety measures

Festoon systems for C-rails

Program 0230 / 0240 / 0250 / 0255 / 0260

10.2 Disassembly

After the system is no longer in use, the festoon system must be disassembled and environmentally friendly disposal carried out.

Before starting disassembly:

- Remove operating and auxiliary materials as well as residual processing material, and dispose of them in an environmentally appropriate manner.

Then clean the assemblies and components properly and disassemble them as required by applicable local workplace safety and environmental protection regulations.

Personnel:

- May only be carried out by trained technicians
- At least two people

Tools needed:

- Crescent wrench
- Securing tool



Risk of injury due to lack of care when securing loads!

Loads are to be carefully fastened onto suitable hoists or load-carrying devices that are technically intact and have sufficient load capacity.

10.3 Disposal

Properly disassembled components are to be recycled if no return or disposal agreement has been made.

- Scrap metals.
- Take plastic elements for recycling.
- The other components are to be disposed of according to their material composition.



Environmental damage due to improper disposal!

Electrical waste, electronic components, lubricants, and other auxiliary materials are subject to hazardous waste disposal regulations and may only be disposed of by authorized specialists.

Local community officials or special disposal companies can provide information about environmentally appropriate disposal.

Festoon systems for C-rails

Program 0230 / 0240 / 0250 / 0255 / 0260

11 Additional documentation

11.1 Installation declaration

The Declaration of Incorporation is available as a separate document.

11.2 Documentation for electrical equipment

See separate electrical documentation.

11.3 Replacement parts list



NOTE!

Keeping a stock of the most essential spare and wear parts at the place of installation ensures constant operational readiness of the system.



WARNING!

Safety risk due to wrong spare parts!

Wrong or faulty spare parts can impair safety as well as result in damages, malfunctions or complete failure.

Use only original spare parts of the manufacturer!

No liability is accepted or warranty given for damages that occur from the use of unauthorized spare parts and accessories.

For spare part orders, please indicate the following data:

- Order number
- Part number
- Description
- Unit count
- Desired mode of shipping (postal, freight, sea, air, express)
- Shipping address

Festoon systems for C-rails

Program 0230 / 0240 / 0250 / 0255 / 0260

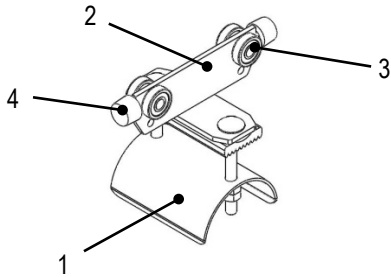

Fig 49.: Cable trolley

■ Replacement parts available:

- 1) Support, complete with clamping strip and mounting elements
- 2) Cable trolley upper part, complete with rollers and buffers
- 3) Roller pair
- 4) Buffers

The exact replacement part name can be found in the project-specific replacement parts list.

Festoon systems for C-rails

Program 0230 / 0240 / 0250 / 0255 / 0260

11.4 Product observations

We strive to observe our products after delivery in order to further improve them and better meet your needs.

Please use the form on the following pages to communicate your experiences and issues with us that could be of interest for our improvement process.

Thank you very much for your help.

Please fax the filled out form to: +49 7621 662 284

For example:

- changed conuration data
- experiences with the festoon system
- recurrent errors
- difficulties with documentation

Your contact data

Company:	Cust. No.:

Department:	

Contact Person:	

Address:	Zip code:

PO Box:	

City:	

Phone:	Fax:

E-mail:	

Your experiences and observations:

Festoon systems for C-rails

Program 0230 / 0240 / 0250 / 0255 / 0260

11.5 Final handover document

Customer:	Cust. No.:
	Order No.:
	Contractor:
	Order confirmation no:

Construction location:	Project name:	
	Address:	
	Postal code:	City:
	Contact person / tel. no.:	Meeting place:
Start of installation (on site)		End of installation (on site)
Installation time required (in hours):		Travel time required (in hours):

Installation of the above project was concluded today by Conductix-Wampfler GmbH, Germany.

Risk is transferred to the customer today.

The acceptance was confirmed in the customer-specific "Handover" protocol:	yes	<input type="checkbox"/>	Attachment:
The maintenance instructions were handed out:	yes	<input type="checkbox"/>	
CE label was attached:	yes	<input type="checkbox"/>	

Customer remarks:

Supplier remarks:

The following tasks included in the order could not be carried out:

Contact for installation (Conductix-Wampfler GmbH)		Contact for construction (customer)	
Name:		Name:	
Date:	Signature:	Date:	Signature:

Installation instructions

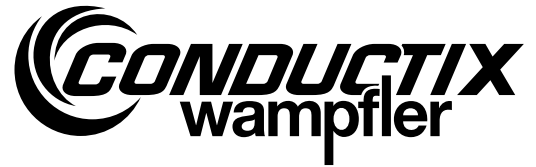

Festoon systems for C-rails

Program 0230 / 0240 / 0250 / 0255 / 0260

Conductix-Wampfler GmbH
Rheinstraße 27 + 33
79576 Weil am Rhein - Märkt
Germany

Phone: +49 (0) 7621 662-0
Fax: +49 (0) 7621 662-144
info.de@conductix.com
www.conductix.com



Importer for the United Kingdom:
Conductix-Wampfler Ltd.
1, Michigan Avenue
Salford
M50 2GY
United Kingdom

Phone: +44 161 8480161
Fax: +44 161 8737017
info.uk@conductix.com
www.conductix.com